

APP-6

MILITARY SYMBOLS FOR
LAND BASED SYSTEMS

July 1986



North Atlantic Treaty Organization

Military Agency for Standardization (MAS)

NATO Letter of Promulgation

19 November 1984

1. APP-6 - Military symbols for land based systems is a NATO UNCLASSIFIED publication. The agreement of nations to use this publication is recorded in STANAG 2019.
2. APP-6 is effective upon receipt.

M.KORKOLIS
Major-General, HEAR
Chairman

Chapter	Record of reservations by Nations
1	
2	
3	
4	
5	
6	

Record of changes

Change number	Change date	Date entered	Effective date	By whom entered

APP-6

Military Symbols for
Land Based Systems

By Command of the Defence Council

July 1986

MINISTRY OF DEFENCE
NATO Military Standardization and Terminology

D/DASD/22/10/1

Contents**Chapter 1 Basic information**

0101 Purpose	1-1
0102 Scope	1-1
0103 Distribution	1-1
0104 Limitations	1-2
0105 Definitions	1-2
0106 Related documents	1-3
0107 Colour representation	1-3
0108 Fields	1-5
0109 Contents of fields	1-7

Chapter 2 Units, posts and installations, and equipment

0201 Basic symbols	2-1
0202 One-colour representation	2-2
0203 Solid or broken lines	2-2
0204 Equipment	2-3
0205 Fields	2-4
0206 Mandatory fields	2-4
0207 Conditional fields	2-6
0208 Optional fields	2-6
0209 Optional fields (enemy only)	2-12
0210 Location of symbol on the map or display	2-12
0211 Examples	2-14
0212 Unit type indicator	2-17
0213 Headquarters representation	2-18
0214 Basic unit role indicators	2-19
0215 Composite role indicators	2-24
0216 Size indicators	2-25
0217 Symbols associated with size indicators	2-27
0218 Observation post indicator	2-27
0219 Logistic installation indicator	2-28
0220 Electronic installation role indicators	2-28
0221 Landing site indicators	2-29
0222 Basic logistic installation role indicators	2-29
0223 Composite logistic installation role indicators	2-31
0224 Electronic installation role indicators	2-33

0225 Electronic installation activities	2-33
0226 Equipment indicators	2-34
0227 Composite equipment indicators	2-37
0228 Mobility indicators	2-39
0229 Location of content of fields	2-40

Annex A to Chapter 1

Method of Marking Unknown or Unidentified Enemy Units	2-A-1
--	-------

Chapter 3 Terrain and tactical activities

0302 General points	3-1
0303 Points	3-3
0304 Military fortifications	3-4
0305 Nuclear, biological or chemical events	3-4
0306 Lines	3-5
0307 Areas and positions	3-9
0308 Fire-planning symbols	3-17
0309 Obstacles	3-19
0310 Movements	3-24
0311 Mission or Intention Symbols	3-27
0312 Fields for symbols	3-27
0313 Examples of symbols	3-35

Chapter 4 Automated displays - display rules and information content**Chapter 5 Glossary of terms for use with APP-6**

List of Effective Pages	LEP-1
--------------------------------	-------

CHAPTER 1

Basic information

0101. Purpose

1. APP-6 replaces STANAG 2019 (Edition 2) *Military Symbols* which was designed for manual map marking. The contents of APP-6 constitute a single system of military symbology for land-based formations and units, which can be used for either automated map display systems or for manual map marking.
2. As automated methods of display are still largely theoretical and are not yet based on practical military experience with automated display techniques using automated data processing (ADP), there may be a requirement for modifications or amendment after practical ADP systems have been used in tactical formations and units. Such changes will be made by means of formal amendments as required.

0102. Scope

1. The military symbols contained in APP-6 will be used on:
 - a. Situation maps, overlays, air photograph annotations and intelligence maps.
 - b. Maps used by Naval and Air Forces when involved in land-based operations.
 - c. Diagrams contained in STANAGs, Allied Publications and other NATO documents.
2. These symbols will not be used for:
 - a. Naval plotting.
 - b. Military geographic information and documentation.
 - c. Telecommunications diagrams.

0103. Distribution

This publication is intended for use by all types of NATO forces and by all ranks.

0104. Limitations

1. The decision to have a common set of symbols for both manual and ADP use means that users will, in future, have to limit themselves to what is possible with current ADP technology. In particular the following limitations must be borne in mind.
2. *Framework.* APP-6 does not attempt to produce a symbol for every military unit, tactic or equipment. Instead it produces a number of basic symbols which users can superimpose, one on another, to produce the required result. In addition, it is recognized that each nation is likely to require several specialist symbols on its own.
3. *Location.* Each symbol must be capable of being positively and accurately positioned on an ADP display. This means that each symbol must contain at least one location point that will fix its position on the display.
4. *Size and detail.* Current ADP displays are not capable of producing very fine detail. If too much detail is included or if the size of the symbol is reduced too far, the lines merge on the display and the symbol becomes blurred.
5. The key to defining symbols, particularly when shown on an ADP screen is the shape, not whether the symbol is open or filled. For example.



Both have the same meaning.
Civil Military Affairs

0105. Definitions

1. 'Military symbol' is defined as:

A graphic sign used, usually on a map, display or diagram to represent a particular military unit, installation, activity or other item of military interest (AAP-6). It may be in colour and is normally accompanied by alphanumeric characters.

2. The military, tactical, logistics or other terms used in this publication are defined, where necessary, in AP-6 or in the glossary of ATP-35.
3. The national equivalents of the various levels of formations whose symbols are shown in this publication, are set out in STANAG 2356.
4. Chapter 5 gives a glossary of terms for use with APP-6.

0106. Related documents

1. Reference is made in this publication to various STANAGs. There is no requirement for most users to refer to the actual STANAGs, all of which are, in any case, implemented in publications issued by nations and allied headquarters. However, for information the STANAGs are:

STANAG 1059 - National Distinguishing Letters for use by NATO Forces

STANAG 2022 - Intelligence Reports

STANAG 2077 - Order of Battle Non-NATO Forces

STANAG 2356 - Comparative Formation/Unit Installations

2. Reference is made also to Allied Publications that are issued on a wide distribution and which may be available to users. These are:
 - a. *AAP-6*. NATO Glossary of Terms and Definitions (English and French).
 - b. *ATP-35*. Land Force Tactical Doctrine.

0107. Colour representation

1. Ideally, different colours will be used to differentiate between enemy and friendly symbols. However, it is necessary to provide for both one-colour and multi-colour representation of symbols.

3. *Multi-colour representation*

- a. *Blue* (blue or black for manual systems). Friendly units, posts and installations, equipments, activities and ground environment symbols, not covered by the colours listed below.
- b. *Red*. Enemy units, posts and installations, equipments, activities and ground environment symbols, not covered by the colours listed below.
- c. *Yellow*. Friendly and/or enemy NBC events, such as chemical or radiological areas and enemy biological areas.
- d. *Green*. Friendly and/or enemy man-made obstacles.
- e. *Others*. Other colours are spare and if used, must be explained in a legend.

4. *Limited-colour representation*

- a. In cases where only a few colours are available, the following guidelines are to be used. An example would be an ADP system that had only a limited capability to show colours. When colours are limited, friendly forces should always be shown in black or blue.
- b. *2 colours*
 - (1) One colour (ideally blue, black or green) for friendly symbols.
 - (2) One colour (ideally red) for enemy symbols.
- c. *3 colours*
 - (1) One colour (ideally blue or black) for friendly symbols not listed below.
 - (2) One colour (ideally red) for enemy symbols not listed below.
 - (3) One colour (ideally yellow or green) for NBC events and/or man-made obstacles, both friendly and enemy.

0108. Fields

1. Fields are a combination of letters, numbers and/or abbreviations grouped in and around the basic symbol to provide additional information.
2. In order to show military symbols on an ADP screen, it is necessary to have strict rules about the position and length of each field. For example, if all the permitted alphanumeric spaces to the left and right of a basic symbol were used, plus the width of the symbol itself, the total length would be half the width of the average ADP screen.
3. The rules concerning the position and length of fields grouped round a basic symbol are as follows:
 - a. *Above.* Not more than 2 fields, each of not more than 6 alphanumeric characters.
 - b. *Right.* Not more than 4 fields, each of not more than 21 alphanumeric characters. However more than one type of information may be included in each of these fields provided that the maximum length is not exceeded.
 - c. *Below.* Not more than 2 fields, each of not more than 6 alphanumeric characters, plus (if required) an arrow to show 'direction of movement'.
 - d. *Left.* Not more than 4 fields, each of not more than 15 alphanumeric characters.
 - e. These are shown on the sketch below:

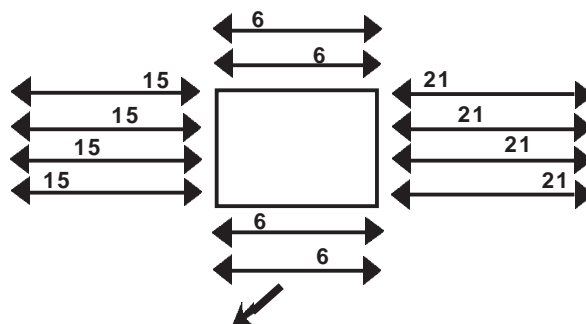

4. Each field is identified by the following:
 - a. *Field title.* The name given to a particular position in relation to the basic symbol: an example is 'Unique designation'.
 - b. *Field length.* The maximum number of alphanumeric figures that may be used in that particular field. It is shown after the field title: for example 'Unique designation (15)'. In some cases, the field length is less than the total number of character spaces; this is to allow for two field titles to appear on the same line. For example, 'Combat effectiveness' (5 spaces), plus an oblique stroke, plus 'Free text' (15 spaces), adds up to the maximum 21 alphanumeric characters permitted to the right of a basic symbol.
 - c. *Field letter.* The position of each field in relation to the basic symbol is shown on a field diagram by means of a letter that stands for the field title; for example, the position of 'Unique designation' is indicated by the letter 'T'.
5. Not all fields are applicable to all basic symbols, but in each case the position and maximum length is constant and obligatory. The field diagram set out on the next page shows the position of most fields.
6. Detailed information on the layout and content of each field, plus the appropriate diagrams, is given in the following paragraphs:
 - a. Units, posts and installations and equipment - paragraph 0229.
 - b. Terrain and tactical activities - paragraph 0311.

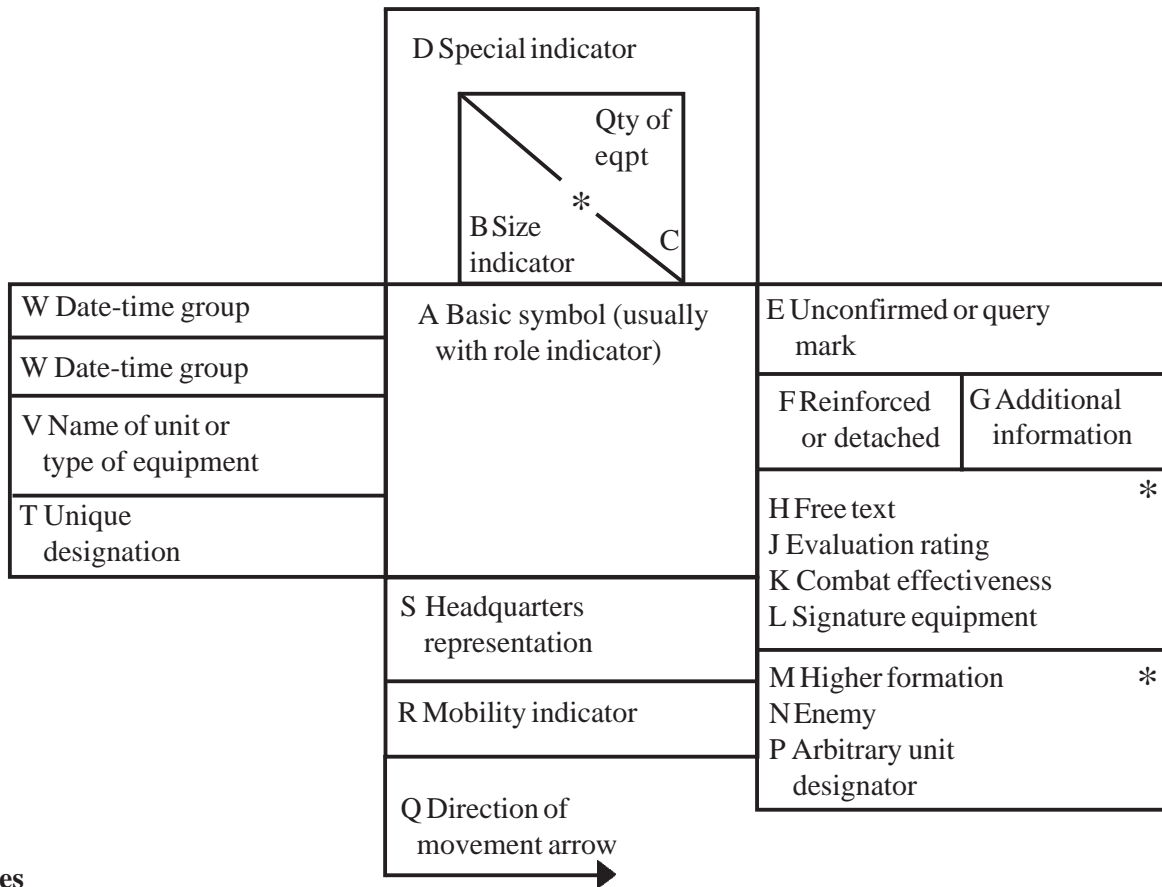





Notes



1. * Which of these field titles will appear in this field depends on which role indicator is shown.
2. The letters 'I', 'O' and 'U' have not been used to indicate fields to avoid confusion.
3. Fields H, J, K, L and M, N, P should not exceed 21 characters.

0109. Contents of fields. Explanatory text and examples to elaborate on the contents of fields are contained in the following sub-paragraphs. "Applicable to all" throughout the tables refers to formations, units, equipment, installations and posts:

1. *Mandatory fields*



Field Letter	Field Length	Field Title	Example	Remarks
(a)	(b)	(c)	(d)	(e)
A	NA	Basic symbol and role indicator		<p>a. Example shows the basic symbol for a formation or unit and the role indicator is that for mechanized infantry.</p> <p>b. Applicable to all.</p>
B	6	Size indicator		<p>a. Example shows an <i>enemy tank</i> regiment.</p> <p>b. Applicable to all.</p> <p>c. Mandatory for formations and units.</p> <p>d. Should be used for installations when name is not ambiguous.</p> <p>e. May be used with equipment.</p> <p>f. Query mark, "?", permitted.</p>
P	21	Arbitrary unit designator	 1UK567UR	<p>a. Applicable to enemy formations, units, installations and equipments only.</p> <p>b. See paragraph 0206 for further detail.</p> <p>c. Assigned when identification of enemy is incomplete or doubtful.</p>
T	15	Unique designation	8 CH 	<p>a. Example shows 8th Canadian Hussars (8 CH).</p> <p>b. Applicable to all except <i>enemy</i> equipment.</p> <p>c. If unique designation is not known or is unconfirmed, a Query mark, "?", <i>must</i> be shown</p> <p>d. It must always match the size indicator. If size indicator is not shown, unique designation must include the size.</p>



2. Conditional information fields

Field Letter	Field Length	Field title	Example	Remarks
(a)	(b)	(c)	(d)	(e)
D	NA	Special size		<ul style="list-style-type: none"> a. Example shows mechanized infantry formation or unit in special grouping, ie combat team, battle group, brigade group etc. b. Applicable to formations, units and installations. c. Must be displayed when applicable.
N	2	Enemy indicator		<ul style="list-style-type: none"> a. Example shows an enemy mortar. b. Applicable to enemy equipment only. c. Not required when symbols can be identified as enemy by the colour red.

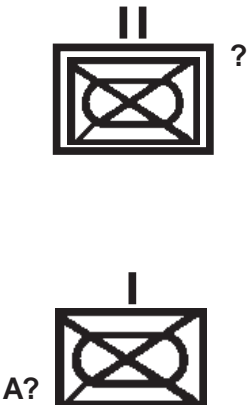
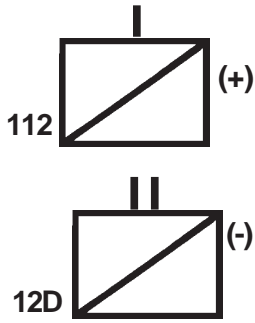

3. Optional information fields

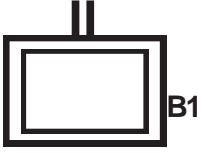
Field Letter	Field Length	Field title	Example	Remarks
(a)	(b)	(c)	(d)	(e)
C	6	Quantity of equipment		<ul style="list-style-type: none"> a. Example shows six mortars. b. Applicable to equipment only. c. Used to show the numbers of equipment. d. Query mark, "?", may be included when quantity is not known or is unconfirmed.

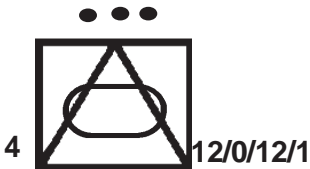
(a)	(b)	(c)	(d)	(e)
E	1	Unconfirmed		<p>a. The example shows what is thought to be an enemy motor rifle battalion but <i>all</i> information is unconfirmed.</p> <p>b. Applicable to all.</p> <p>c. Example two shows only the fact that it is A Company and unconfirmed. Query mark, "?", is inserted in this field (T).</p>
F	3	Reinforced or detached		<p>a. Examples show 112 Reconnaissance Squadron reinforced and 12 Dragoons with squadron(s) detached.</p> <p>b. Applicable to all <i>less</i> enemy equipment.</p> <p>c. This field is always shown in brackets.</p> <p>d. Used to show change in size as (+) or (-) to indicate that units or sub-units are attached or detached.</p>
G	17	Additional information		<p>a. Used for notes by the user.</p> <p>b. Applicable to all but should be used restrictively to avoid overloading ADP displays.</p> <p>c. Contents of this field may not necessarily be transmitted to other units or formations.</p>
H	21	Free text		<p>a. Used for additional information not covered by other fields.</p> <p>b. Applicable to all but should be used restrictively to avoid overloading ADP displays.</p> <p>c. Query mark, "?", permitted with enemy information.</p> <p>d. Important information which should be transmitted to other units or formations should be in this field <i>not</i> in field G.</p>

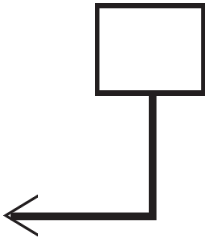
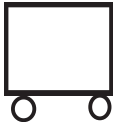
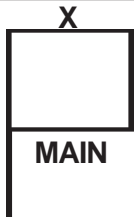
(a)	(b)	(c)	(d)	(e)
J	2	Evaluation rating		<ul style="list-style-type: none"> a. Applicable to enemy only. b. Consists of one letter and one figure to show source and information gradings. c. If field H is also used, then field H is used first and is separated by an oblique stroke.
K	5	Combat effectiveness		<ul style="list-style-type: none"> a. Applicable to all formations, units and installations. b. If field H is also used, then field H is used first and is separated by an oblique stroke. c. May be displayed as CE (Combat Effectiveness) followed by a space and two figures or as "%" (Percentage Effectiveness) followed by a space and two figures.
L	1	Signature equipment		<ul style="list-style-type: none"> a. Applicable to <i>enemy</i> equipment only. b. If the enemy equipment emits a signature, indicate by use of an exclamation mark, "!". c. If field H is also used, then field H is used first and is separated by an oblique stroke.
M	15	Higher formations		<ul style="list-style-type: none"> a. The example shows 4th Platoon, 12th Anti Armour Company, 12th Mechanized Brigade of 1st Armoured Division. b. Applicable to all. c. Higher formation field (M) is used to show <i>some or all</i> of its higher units or formations. d. Sequence of size indicators must follow those given in paragraph 0208.7d.

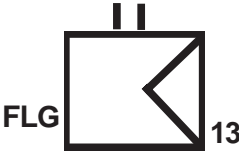
(a)	(b)	(c)	(d)	(e)
				<ul style="list-style-type: none"> e. If one of the sequence is unknown, a Query Mark, "?", is shown. f. For each part of the sequence not used, a "0" is inserted. g. Normally for manual display, the higher formation field may be abbreviated as in example two.
Q	NA	Direction of movement arrow		<ul style="list-style-type: none"> a. The example shows a unit moving West. b. Applicable to all. c. The example indicates the general direction in which the unit is moving but not the precise route. d. The arrow is always positioned at the location point of the symbol.
R	NA	Mobility indicator		<ul style="list-style-type: none"> a. Applicable to formations, units and equipment. b. A pictorial representation of mobility, as contained in paragraph 0228, is used.
S	15	Headquarters representation		<ul style="list-style-type: none"> a. The example shows a brigade Main headquarters. b. Applicable to all formations and units. c. A Query mark, "?", may be used at the end of the information in this field if it is unconfirmed. A Query mark, "?", should be shown in this field if the information is unknown or unconfirmed. d. The words MAIN, REAR, ALTN, TAC or STEPUP may be used.

(a)	(b)	(c)	(d)	(e)
V	15	Name of unit or type of equipment	 	<p>a. Example one shows FLG, 13/ Service Battalion. Example two indicates an enemy anti-tank gun thought to be 120mm but this information has not been confirmed.</p> <p>b. Applicable to all.</p> <p>c. This field is used to show the classification, or type of formation, unit, installation or equipment.</p> <p>d. A Query mark, "?", may be used at the end of the information in this field if it is unconfirmed or on its own if the information is unknown.</p>
W	15 and 15	Date-time-group	<p>NMB 041000Z [</p> <p>FROM 1200Z [</p> <p>TO 2300Z]</p>	<p>a.. Example one shows No Move Before (NMB) 1000 hours ZULU on the 4th day of the current month. Example two shows an action is in effect from 1200Z to 2300Z hours only.</p> <p>b. Applicable to all.</p> <p>c. Two "W" fields are used to allow for both "FROM" and "TO" to be shown.</p>

CHAPTER 2**Units, posts and installations, and equipment****Part 1 Guide to Use****0201. Basic symbols**

1. A unit is represented by:



2. A headquarters or an element of a headquarters is represented by:



3. An observation post is represented by:



4. A logistic or administrative installation is represented by:



5. An electronic installation is represented by:



6. A landing site is represented by:



7. National non-NATO forces are represented by:



0202. One-colour representation:

When only one colour is used, the basic symbols for enemy units will be drawn with a double line:

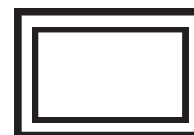

An enemy unit

Where double lines cannot be used, such as on equipment symbols, the letters 'EN' will accompany:



0203. Solid or broken lines

1. A *solid* line will be used to indicate:

- a. Present or actual locations.
- b. Objectives.
- c. Boundaries.

2. A *broken* line will be used to indicate a future or projected location:

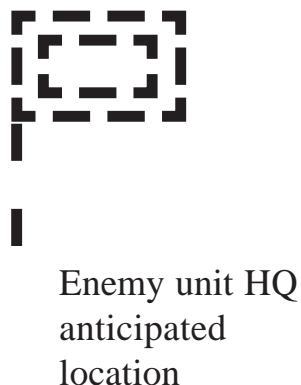

0204. Equipment

1. Unless otherwise stated, the exact location of the equipment is indicated by the centre of the base of the symbol.
2. Equipments are indicated by the basic weapon symbol for a gun or howitzer with the calibre shown in field V:

a. Light gun or howitzer:



c. Medium gun or howitzer:



d. Heavy gun or howitzer:



3. Additions are made to indicate the type of equipment:

a. Light gun in anti-tank role



b. A gun in anti-aircraft role



c. Multi-barrel rocket launcher



0205. Fields

1. Fields are a combination of letters, numbers and/or abbreviations grouped in and around the basic symbol to provide additional information.
2. An explanation is set out at paragraph 0108 and detailed information on each field is set out at paragraph 0229. Paragraphs 0206, 0207, 0208 and 0209 explain the use of each field.

0206. Mandatory fields

The following information is mandatory and must be completed if applicable. If the information is not known, a query mark must be shown in its place.

1. *Role indicator (-)(A)*. A symbol is placed within the basic symbol to show the type of unit or installation; it may be a composite symbol combining two or more types:



An armoured unit



A fuel installation for Air Force fuel

2. *Size indicator (6)(B)* (mandatory for units only, but could be used also with some installations and/or equipment; see paragraph 0229). A symbol is placed on top of the basic symbol to show the size:

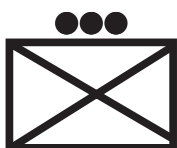

An infantry platoon



A Main Repair Group (MRG) manned by a company size unit

3. *Unconfirmed or query mark (1)*
 - a. When an aspect of a mandatory field is unknown, a query mark, "?", by itself, must appear in that field.
 - b. When one aspect of a mandatory field is doubtful, a query mark, "?", should be placed at the end of the information in that field.
4. *Arbitrary unit designator (13)(P)*. A number, letters or combination of both is used to designate an HQ, unit or formation whose correct title is unknown. Further details on the method of allocation of an Arbitrary Unit Designator are contained in Annex A to this Chapter.



This example indicates that HQ NORTHAG have located what they believe to be an enemy MRD and have allocated the arbitrary unit designator of 369.

5. *Unique designation (15)(T)*
 - a. Gives the title of the unit, etc. It must always match the size indicator:

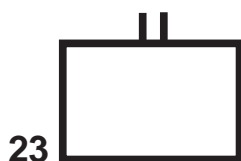

Indicates No. 23 Battalion

- b. If a size indicator is not shown, for example with an item of equipment, then the unique designation should include an abbreviation, such as ‘pl’ (for platoon) to indicate size.

0207. Conditional fields

The following fields are conditional, and must be completed if the conditions which they indicate are applicable.

- 1. *Special indicator (-)(D)*. Must be displayed when applicable.



Armoured Infantry unit in special grouping, such as a Combat team

- 2. *Enemy (shown as ‘EN’)(2)(N)*. Must be used for equipment if one-colour representation is used; if an arbitrary unit designator (field P) is shown also, ‘EN’ will be shown before the arbitrary unit designator.

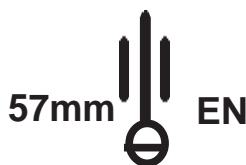

An enemy anti-aircraft gun of 57mm calibre

0208. Opti elds

The following fields are optional and should be completed when required.

- 1. *Quantity of equipment (6)(C)*. To show numbers of an equipment. Where the quantity is unconfirmed a query mark may be added:



4 x 81mm mortars (see paragraph 0206.3)

2. *Reinforced or Detached (3)(F)*. Used to indicate if reinforced or if part is detached. Always shown in brackets:

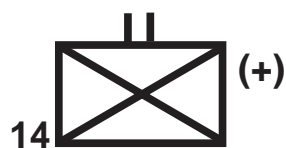

14 Infantry battalion reinforced



15 Infantry battalion with part detached

3. *All information unknown (1)(E)*. When all the information contained in a symbol is doubtful or unconfirmed, a query mark, "?", must be placed in field E.
4. *Additional information (17)(G)*. Space for the writer to make notes; however information in this space will *not necessarily* be transmitted via ADP.



14 Infantry battalion reinforced, but with note to check again at 1200 hrs

5. *Free text (15)(H)*. Space to write additional information which *will* be transmitted via ADP:



The water is not for human consumption

6. *Combat effectiveness (5)(K)*

a. An indication of the effectiveness of the unit (friendly or enemy) may be shown as:

- (1) Combat effectiveness ('CE' plus %), or
- (2) Percentage effectiveness ('PE' plus %).
- (3) If field H (free text) is to be used also, put an oblique stroke after field K:



Combat effectiveness = 10% for a friendly unit



Percentage effectiveness = 20% for an enemy unit

7. *Higher formation (15)(M)*

- a. The unique designation (field T) gives the title of the unit or other symbol portrayed, and must always match any size indicator shown.
- b. The higher formation field (field M) is to show some or all of its higher units or formations. They are shown with an oblique stroke between each one.
- c. It should show their abbreviated title and it may include national distinguishing letters.
- d. It must follow the sequence of size indicators given in STANAG 2356, which is as follows:

Group	Size indicator	Generic Term
1	●	-
2	●●	-
3	●●●	Platoon
4	●●●●	Echelon
5	I	Company
6	II	Battalion
7	III	Regiment/Group
8	X	Brigade
9	XX	Division
10	XXX	Corps
11	XXXX	Army
12	XXXXX	Army Group
13	XXXXXX	Region

If one of the sequence is unknown, a query mark must be shown. If one of the sequence is not used by a nation, '0' must be shown.

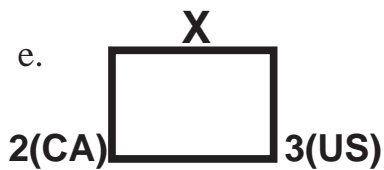

2 (Canadian) Brigade, which is part of 3 (US) Division

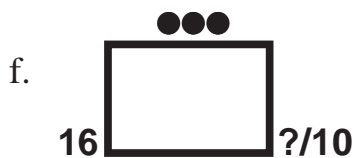

16 Platoon, which is part of an unknown company, which is part of 10 Battalion

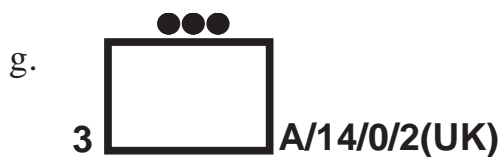

3 Platoon, A Company, 14 Battalion, part of 2 (UK) Brigade. UK does not use 'regiment (III)', so this slot is shown as '0'

8. *Direction-of-movement arrow (-)(Q)*. General indication of the direction of movement

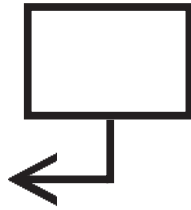

This unit is moving *west*

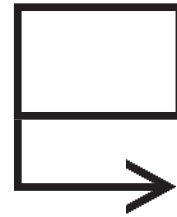

This Headquarters is moving *east*

9. *Mobility indicator (-)(R)*. A pictorial representation of the type of mobility:

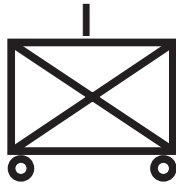

An infantry company in wheeled transport

10. *Headquarters representation (15)(S)*.

- a. A 'shaft' is drawn on the left side of the symbol to indicate a headquarters.
- b. Underneath the symbol may be written an abbreviation to show the type of headquarters. The list of types is given in paragraph 0213.

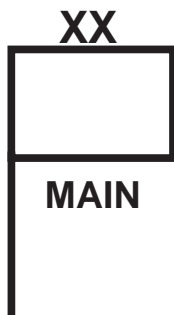



A divisional main headquarters

11. *Name of unit or type of equipment (15)(V)*

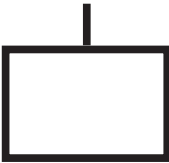
- a. The unique designation (field T) gives the unique title of the unit or installation portrayed.
- b. This field (field V) should show the class or type of the unit, installation or equipment rather than its unique title.
- c. In cases where the name or type is unconfirmed, a query mark should be added.

d. **SPECIAL FORCES**  **B** Company of some Special Forces Unit



e. **BASE WORKSHOP**  A maintenance unit of Base Workshop type of battalion size

f. **120mm?**  An anti-tank gun, thought to be 120mm but not confirmed

12. *Date/time (15/15)(W)*

- a. These fields should contain all information relating to time.
- b. Each field contains up to 15 characters.
- c. Each line should contain figures to represent the date and/or time and *if required* an abbreviation to indicate the purpose of the time.
- d. Two lines are available so as to be able to portray such items as 'from' and 'to' times.

e. **031500A**  Information obtained on the 3rd day of the current month at 1500hrs ALFA time

- f. **NMB 041000Z**  No Move Before (NMB) 1000hrs ZULU time on the 4th day of the current month
- g. **FROM 1200Z**
TO 2300Z  Information effective From 1200hrs ZULU time To 2300hrs ZULU time

0209.Optional fields (enemy only)

The following fields are optional also, but apply to enemy forces only.

1. *Evaluation rating (2)(J)*. Indicates the source and information gradings (these gradings are explained in STANAG 2022). If field H (free text) is to be used also, an oblique stroke should follow the evaluation rating:



A1

The information is graded as 'A1'

2. *Signature equipment (1)(L)*. Indicate by '!' if the equipment emits a signature. If field H (free text) is to be used also, an oblique stroke should follow the signature symbol.



A radar emitting a clearly recognizable signal that will identify it

0210. Location of symbol on the map or the display

1. Each symbol must be capable of being positively and accurately positioned on an ADP display. This means that each symbol must contain at least one 'location point' that will fix its position on the display.
2. However the position of the 'location point' may vary according to the type of ADP system being used.

3. Therefore it is not possible to set out fixed rules. However, as a *general guide*, the location point is likely to be positioned as follows:

a. At the point of the shaft for:

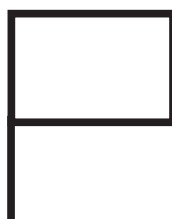

b. At the centre of the bottom for:



c. At the end of a 'location vector' which starts from one of the above location points, when it is necessary to offset the symbol from its current position:

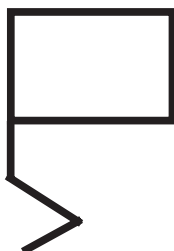

d. When there are two or more staffs at the same location, the symbols can be placed on one location vector:



e. When more than one unit, installation or equipment are located at the same location, they can be indicated by:

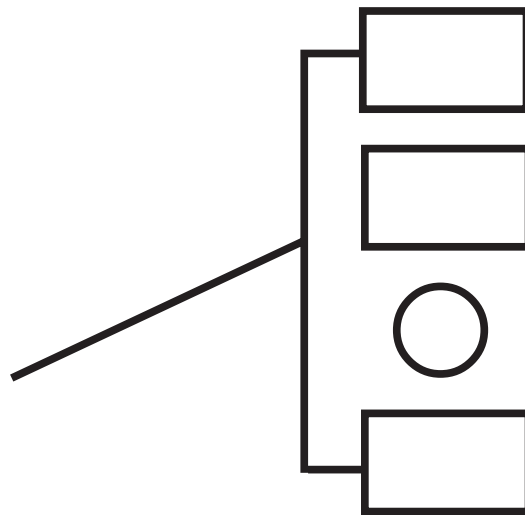

0211. EXAMPLES

1. *One-colour representation*

a. *Friendly forces*

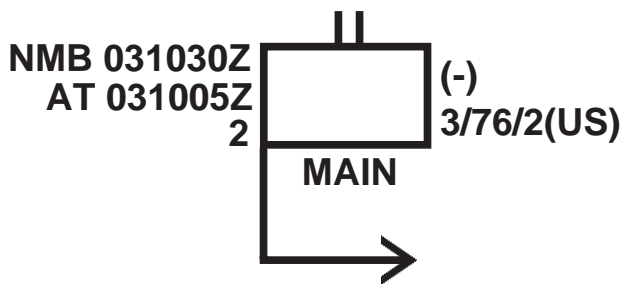

Main Headquarters of the 2nd Battalion, 3rd Regiment, 76th Brigade, less a significant detachment. The unit is under command of 2 (US) Div. The information is valid at 1005Z on the 3rd of the month. The HQ is about to move *east*, no move before (NMB) 031030Z

b. *Enemy forces*

(1)

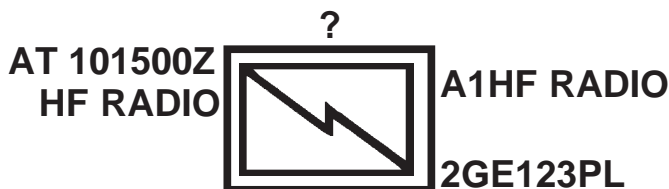

Polish signal unit of unidentified size given an arbitrary unit designator of 123 by 2 (GE) Corps. Unit equipped with HF radio, information graded A1, seen at 101500Z

(2)

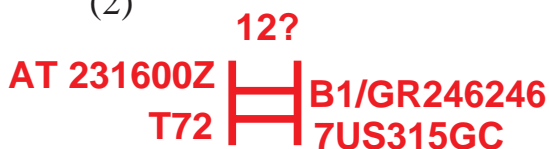

East German tanks of an unidentified unit seen at GR 246246 | believed to be T72. Arbitrary unit designator 315 allotted by 7 (US) Corps. Quantity unconfirmed and graded B1

2. Multi-colour representation

a. Friendly forces

(1) Units

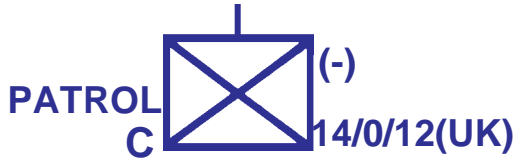

Part of C Company, 14th Infantry Battalion of the 12th (UK) Brigade, (UK does not use 'regiment', so '0' is shown). The Company is being used as a patrol company.

(2) Installations



Water point manned by A Company, 3rd Battalion, 43rd Regiment, due to open at 1000Z on the 3rd day of the current month. Exact location indicated by a vector.

(3) Equipment



4 x 81 mm mortars belonging to the Mortar Platoon (Mor Pl) of 1st Battalion Coldstream Guards (COLDM GDS). Information valid at 0800Z on the 7th of the month.

b. Enemy forces

(1) Units



6th Czechoslovakian Tank Regiment, equipped with T76 tanks, arbitrary unit designator 231 allotted by 1 (BR) Corps, information rated B1.

(2) Post



A Soviet artillery observation post of the 7th Regiment, 16th Brigade. Located at GR 123456. Information as at 0730Z

on the 19th day of the current month. Which battalion is providing the post is not known, and this is indicated by 'BN?' Allotted arbitrary unit designator 241 by 1 (NL) Corps.

(3) *Equipment*

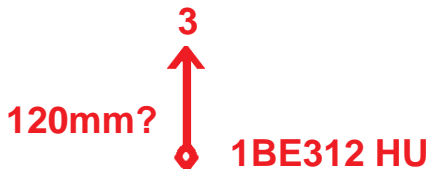

Three Hungarian mortars, thought to be 120mm but not confirmed. Given the arbitrary unit designator of 312 by 1 (BE) Corps.

c. *Landing sites*

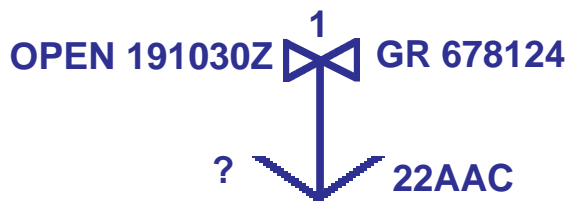

(See Symbol No 8 at Page 2-19). An army helicopter landing site, belonging to an unspecified squadron of 22 Army Air Corps (AAC) at GR 678124. It opens at 1030Z on the 19th day of the current month.

d. *Electronic activities*



A radar-jamming installation (platoon size), part of 24th Battalion, Company not known.







e. *Mobility*



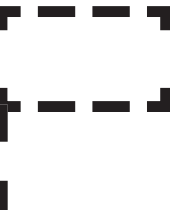

A tracked anti-tank gun (120mm) from 2 Platoon, 1 Company, 43 Battalion.

Part 2 Catalogue of symbols

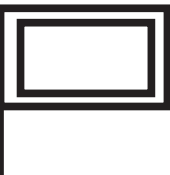
0212.Unit type indicator

Description	Symbol
1. Friendly unit in its present location	
2. Friendly unit HQ in its present location	
3. Planned location for friendly unit	
4. Planned location for friendly unit HQ	
5. Capable of being fully mobilized	
6. Capable of being only partly mobilized	
7. Enemy unit in its present location	
8. Enemy unit HQ in its present location	

Description	Symbol
9. Enemy unit anticipated or suspect location (this is made clear from the supporting fields)	
10. Enemy unit HQ anticipated or suspect location (this is made clear from the supporting fields)	

0213. Headquarters representation









1. Unit Headquarters and Command Posts may be specified by characters underneath the symbol. The following terms in abbreviated form may be used in field S, but may not necessarily appear:

Description	Abbreviated form
a. Advanced	ADV
b. Alternative	ALTN
c. Main	MAIN
d. Mobile	MOB
e. Peacetime	PEACE
f. Rear	REAR
g. Reserve	RES
h. Static	STAT
i. Step-up	STEPUP
j. Tactical	TAC

2. An index of all the abbreviations set out in APP-6 is contained in paragraph 0618.

0214. Basic unit role indicators

These are listed in alphabetical order.

- | | |
|--|--|
| 1. Air defence |  |
| 2. Air Force (see also Symbol No 8 and footnote thereto) |  |
| 3. Airmobile |  |
| 4. Air-transportable |  |
| 5. Amphibious |  |
| 6. Anti-tank |  |
| 7. Armour |  |
| 8. Army aviation (See Footnote) |  (a)  (b) |

Footnote: Both symbols are used within NATO. However, symbol 8(a) is favoured for use in ADP systems because it is clearly distinguishable from the 'Air Force' symbol (0214.2 above). See also Para 0104.5 at Page 1-2.

9. Artillery



10. Bridging



11. Combat service support
(either unspecified role
or multi-role)

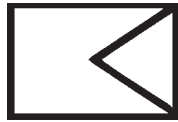

12. Electronic ranging



13. Electronic warfare



For Germany only

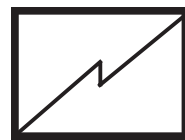

14. Engineer



15. Headquarters support unit



or



16. Infantry



17. Labour resources



18. Maintenance

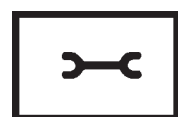

19. Marines



21. Meteorological



22. Military/civil affairs



23. Military police



24. Missile



25. Mountain



26. Navy



27. Nuclear, biological and chemical (NBC)



28. Ordnance



29. Parachute



30. Pay/finance



31. Personnel services



32. Pipeline



33. Postal and/or courier



34. Psychological



For Germany only



35. Quartermaster



36. Reconnaissance



37. Reinforcement/replacement holding unit



For Germany only



38. Service unit



39. Signal/communications



40. Sound ranging



41. Supply



or



42. Transportation/
movement



43. Topographical/survey and/or
map production or map depot



44. Unmanned air
reconnaissance



45. Unspecified or composite all arms
formations (e.g., corps, front)



46. Veterinary



0215. Composite role indicators

In order to depict various types of composite units, the basic symbols should be superimposed upon each other. Both units and/or equipment can be treated in this way. Typical examples are as follows (shown in alphabetical order):

- 1. Air defence artillery



- 2. Air defence missile



- 3. Anti-tank Army Aviation



(See Symbol
No 8 at
Page 2-19)

- 4. Anti-tank missile



- 5. Anti-tank rocket



- 6. Armoured artillery



- 7. Armoured engineers



- 8. Armoured reconnaissance



- 9. Mechanized/armoured infantry in tracked APCs



- 10. Mechanized/armoured infantry in wheeled APCs



- 11. Rocket artillery



0216. Size indicators

For full details of National equivalents, see STANAG 2356.

- 1. Smallest Unit/US Squad/
UK Section

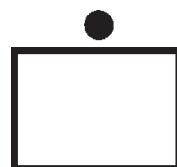

- 2. Unit larger than a US Squad/
UK Section but smaller than a
platoon equivalent

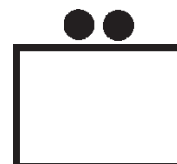

- 3. a. Platoon/
troop equivalent

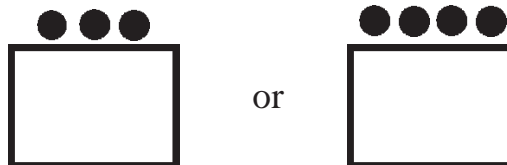

- b. Some nations use:

●●● as the symbol for a platoon of combat troops

●●●● as the symbol for an echelon of command/control or support elements

4. Company/Battery/Squadron equivalent

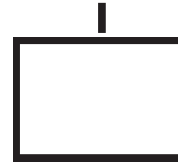

5. Battalion equivalent

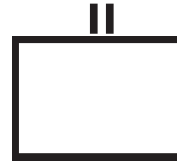

6. Regiment/Group equivalent

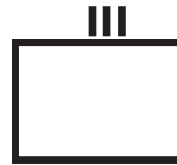

7. Brigade equivalent

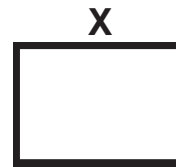

8. Division

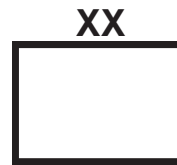

9. Corps

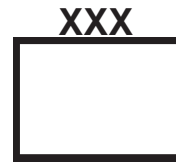

10. Army

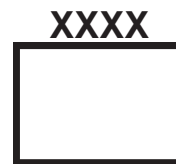

11. Army Group

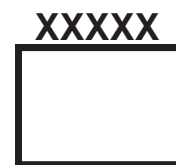

12. Region



0217. Symbols associated with size indicators

1. Non-organic unit or temporary grouping



2. Unknown

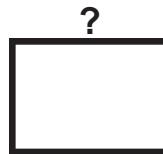

POSTS AND INSTALLATION REPRESENTATION

0218. Observation post indicator

1. Friendly observation post in its present location



2. Friendly observation post's planned location







3. Enemy observation post in its present location







4. Enemy observation post's anticipated or suspect location (this is made clear from the supporting fields)







0219. Logistic installation indicator

- | | | |
|----|--|--|
| 1. | Friendly logistic installation
in its present location |  |
| 2. | Friendly logistic installation's
planned location |  |
| 3. | Enemy logistic installation
in its present location |  |
| 4. | Enemy logistic installation
anticipated or suspect
location (this is made clear
from the supporting fields) |  |

0220. Electronic installation indicator

- | | | |
|----|---|--|
| 1. | Friendly electronic installation
in its present location |  |
| 2. | Friendly electronic installation
in its planned location |  |
| 3. | Enemy electronic installation
in its present location |  |
| 4. | Enemy electronic installation
in its anticipated or suspect
location (this is made clear from
the supporting fields) |  |





0221. Landing site indicators













- | | | |
|----|--|---|
| 1. | Friendly landing site in its present location |  |
| 2. | Friendly landing site in its planned location |  |
| 3. | Enemy landing site in its present location |  |
| 4. | Enemy landing site anticipated or suspect location (this is made clear from the supporting fields) |  |









INSTALLATION ROLE INDICATORS

0222. Basic logistic installation role indicators

These are listed in alphabetical order. Ammunition installations containing one type of ammunition only should be depicted by the basic ammunition symbol with the nature stocked shown in field V.

- | | | | |
|----|------------|---|--|
| 1. | Ammunition |  | |
| 2. | Bridging |  | |
| 3. | Burial |  | For Turkey only
 |









4.	Chemical storage		
5.	Decontamination		
6.	Engineer		
7.	Food		
8.	Fuel		
9.	Hospital		For Turkey only 
10.	Laundry and bath		
11.	Maintenance		
12.	Medical		For Turkey only 
13.	Missile ammunition		

- 14. Movement control 
- 15. Nuclear storage 
- 16. Spare parts 
- 17. Supply  or 
- 18. Water 
- 19. Unknown 
- 20. Combat service support (either unspecified or multi-role) 

0223. Composite logistic installation role indicators

In order to depict various types of composite logistic installations, the basic symbols should be superimposed upon each other. Unit, installation and/or equipment symbols can be used. Typical examples are as follows (shown in alphabetical order).

- 1. Air defence ammunition (gun) 

- | | | | |
|-----|--|--|--------------------------------------|
| 2. | Air defence ammunition
(missiles) |  | |
| 3. | Air Force ammunition |  | |
| 4. | Air Force fuel (fixed wing
or helicopter) |  | |
| 5. | Army aviation ammunition |  | (See Symbol
No 8 at
Page 2-19) |
| 6. | Army aviation fuel (fixed
wing or helicopter) |  | (See Symbol
No 8 at
Page 2-19) |
| 7. | Artillery ammunition (gun) |  | |
| 8. | Artillery ammunition
(missile) |  | |
| 9. | Rocket ammunition
(rocket) |  | |
| 10. | Mines and explosives |  | |

0224. Electronic installation role indicators

Shown in alphabetical order.

- 1. Air defence radar



- 2. Artillery locating



- 3. Electronic warfare



For Germany only



- 4. Ground sensor/ground surveillance radar



- 5. Signal communications





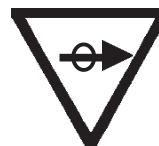

- 6. Target designator, eg laser, infrared



0225. Electronic installation activities

Shown in alphabetical order.







- 1. Direction finding 
- 2. Emitting 
- 3. Intercepting 
- 4. Jamming 

EQUIPMENT REPRESENTATION

0226. Equipment Indicators

Unless otherwise stated, the exact location of the equipment is indicated by the centre of the base of the symbol.







Equipment is shown grouped according to type.

Equipment	Light	Medium	Heavy
1. Aircraft			
a. Air Force fixed wing aircraft size and type unspecified			
b. Air Force helicopter			
c. Army fixed-wing aircraft			

(See Symbol No 8 at Page 2-19)





	Equipment	Light	Medium	Heavy	
d.	Army helicopter				(See Symbol No 8 at Page 2-19)
e.	Army attack helicopter				
f.	Bomber, size unspecified				
g.	Fighter, size unspecified				
2.	Electronics				
	Radar				
3.	Ships				
a.	Naval ship, size unspecified				
b.	Submarine, size unspecified				
c.	Hovercraft, size unspecified				

Equipment	Symbol
4. Weapons	
a. Anti-tank gun	
b. Anti-tank missile launcher	
c. Anti-tank rocket launcher	
d. Flame thrower	
e. Gun	
f. Howitzer	
g. Machine gun	
h. Mortar	
i. Surface-to-air missile launch	

Equipment	Symbol
j. Surface-to-surface tactical missile launcher	
5. Vehicles	
a. Armoured Personnel Carrier (APC)	
b. General symbol for armoured vehicle	
c. General symbol for unprotected vehicle	
d. Mechanized Infantry Combat Vehicle (MICV)/Infantry Fighting Vehicle (IFV)	
e. Tank	

0227. Composite equipment indicators

In order to depict various types of composite equipment, the basic symbols should be superimposed upon each other. Typical examples are as follows (shown in alphabetical order).

Equipment	Symbol
<p>1. Army Anti-tank helicopter</p>	<p>(See Symbol No 8 at Page 2-19)</p>   <p>Germany only</p>
<p>2. Armoured vehicle bridge laying (AVLB)</p>	
<p>3. Engineer vehicles</p> <p>a. There are a wide variety of engineer vehicles and attachments, such as 'mine plough' or 'dozer blades', that can be fitted.</p> <p>b. In order to simplify/reduce the number of symbols, the symbol  has been selected as the general indication of an engineer vehicle. This should be attached to the appropriate vehicle symbol and field V should then be used to say what attachment is fitted.</p>	
Equipment	Symbol

c. Examples are:

(1) Tank with mine plough

MINE PLOUGH



(2) Tracked vehicle armoured with dozer blade

DOZER







(3) Wheeled vehicle for load carrying

10 TON LOAD











4. **Gun in anti-aircraft role**



	Equipment	Symbol
5.	Gun in anti-tank role	
6.	Multi-barrel rocket launcher	
7.	Reconnaissance Air Force aircraft, size not specified	
8.	Air Force transport aircraft, size not specified	

0228. Mobility indicators

To be shown in field R, underneath a unit or equipment symbol, to indicate the type of mobility. Mobility indicators may be placed in field A to clarify the capability of the unit if required. Shown in alphabetical order.

- 1. Amphibious 
- 2. Oversnow 
- 3. Towed vehicle or a trailer 
- 4. Tracked 
- 5. Wheeled 
- 6. Wheeled, cross-country 
- 7. Wheeled/tracked combination 
- 8. Railway 

0229. Location and contents of fields

- Detailed information on the purpose and layout of fields is given in paragraph 0108. For ease of reference, the field diagram is reproduced here.

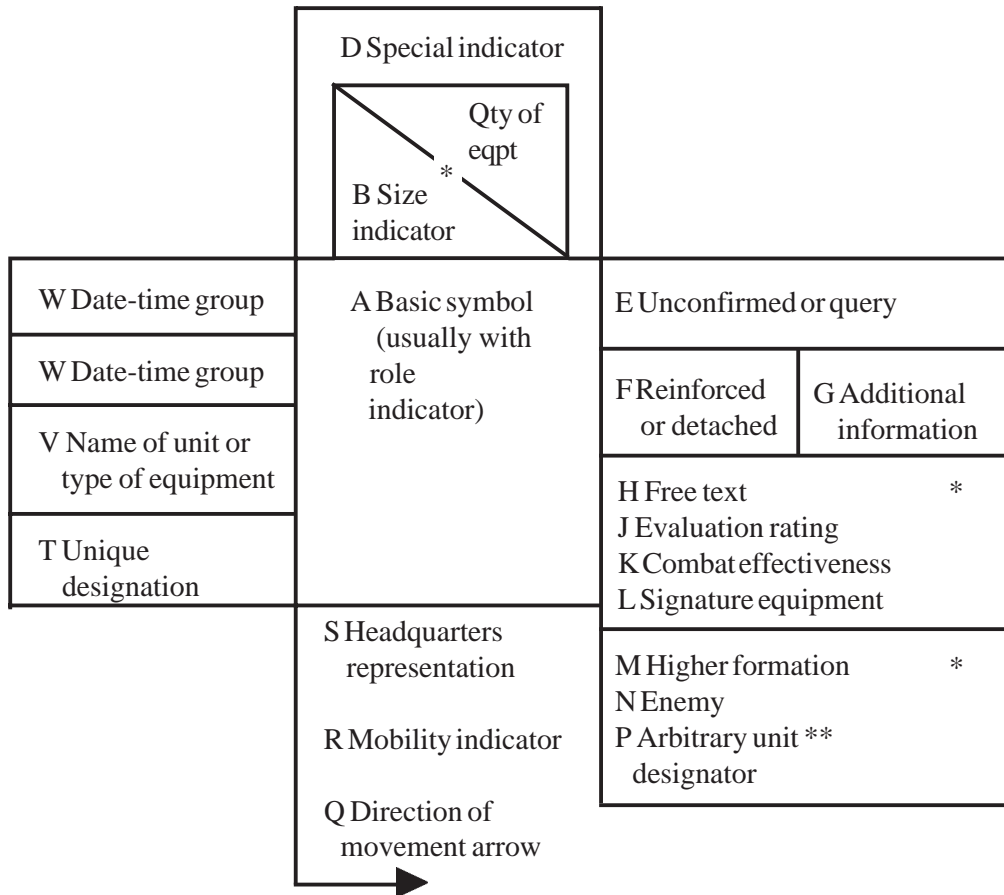

Notes: * Which of these field titles will appear in this field depends upon which role indicator is shown.

The letters 'I', 'O' and 'U' have not been used to indicate fields to avoid confusion.

** See Annex A to this chapter which gives instructions for the method of allocating an arbitrary unit designator.

Annexes:

A. Marking Unknown or Unidentified Enemy Units

2. Content of information fields

Field letter	Maximum field length	Title and	Applicable to description	Remarks
Mandatory fields				
A	-	Basic symbol and <i>role indicator</i> units, posts and installations or equipment symbol (See paragraphs 0214, 0215, 0222, 0223, 0224, 0225, 0226, 0227)	All	-
B	6	<i>Size indicator</i> See paragraph 0216	Units Installations Equipment	a. Mandatory for units b. Should be completed for installations when the number or name of the installation is not unique and unambiguous c. May be used with equipments d. Query mark permitted
P	21	<i>Arbitrary unit designator.</i> to be assigned when the identification of the symbol is incomplete or doubtful	<i>Enemy only</i> Units Installations Equipment	The arbitrary unit designator is allocated in accordance with the instructions in Annex A to this Chapter

Field	Maximum letterfield length	Title and description	Applicable to	Remarks
T	15	<i>Unique designation</i> Unique number or abbreviated title of unit or installation	All less enemy equipment	<p>a. If the unique designation is not known, or is unconfirmed, a query mark must be shown</p> <p>b. May include National distinguishing letters</p> <p>c. The unique designation must always match the size indicator. If a size indicator is not shown, the unique designation must include the size.</p>

Conditional information fields

D	-	<i>Special size indicator</i> (see paragraph 0217)	Units Installations	Must be displayed when applicable
N	2	<i>Enemy</i> indicate enemy equipment by the letters 'EN'	Equipment	Not required when symbols can be identified as 'Enemy' by their colour

Field letter	Maximum field length	Title and description	Applicable to	Remarks
Optional information fields				
C	6	<i>Quantity of equipment.</i> Shows how many equipments are present	Equipment	Query mark may be included
E	1	<i>Unconfirmed.</i> Query mark	All	When all the information is doubtful
F	3	<i>Reinforced or detached.</i> Attached to field F to show change in size as (+) or (-)	All less enemy equipment	This field is always shown in brackets
G	17	<i>Additional information.</i> For notes by the user	All	The contents of this field may not necessarily be transmitted to other users
H	15	<i>Free text.</i> Space for additional information not covered by the other fields	All	a. Query mark permitted with Enemy information b. Important information, which should be transmitted to other users, should be in this field not in field G

Field	Maximum letterfield length	Title and description	Applicable to	Remarks
J	2	<i>Evaluation rating.</i> Consists of one letter one figure to show source and information gradings	Enemy only	a. For gradings see STANAG 2022 b. If field H is in use also, this comes first, and is then separated by an oblique stroke
K	5	<i>Combat effectiveness.</i> May be displayed as Combat effectiveness (CE followed by space and 2 figures and %) or Percentage effectiveness (PC followed by space and 2 figures and %)	Units Installations	If field H is in use also, this comes first and then separated by an oblique stroke
L	1	<i>Signature equipment.</i> If the equipment is a signature equipment, indicate by '!	Enemy only Equipment	If field H is in use also, this comes first and is then separated by an oblique stroke
M	15	<i>Higher formation.</i> Unique number or abbreviated title of the formation	All	a. Query mark may be included b. May include National distinguishing letters

Field letter	Maximum field length	Title and description	Applicable to	Remarks
				c. Must follow the sequence of sizes given in paragraph 0216
Q	-	<i>Direction-of-movement arrow.</i> Always positioned at the location point of the symbol	All	Indicates the <i>general</i> direction, not the precise route
R	-	<i>Mobility indicator.</i> A pictorial representation of mobility as defined in paragraph 0228	Units Equipment	
S	15	<i>Headquarters representation.</i> Specifies level of headquarters (see paragraph 0212)	Units	Query mark may be included
V	15	<i>Name of unit or type of equipment.</i> Show class, type or query mark	Units Equipment	Where name or type are unconfirmed, a query mark may be added
W	15 and 15	<i>Date/time group.</i> May be supplemented by 'AT' 'FROM', etc to show to what the time applies	All	a. 7 character alphanumeric field for date/time preceded by up to 7 letters to show 'AT' 'TO', etc b. Two fields, each of 15 spaces to allow both 'FROM' and 'TO' or equivalent times to be shown

METHOD OF MARKING UNKNOWN OR UNIDENTIFIED ENEMY UNITS

1. In war it could prove extremely difficult to identify by title a particular unit or formation on the battlefield particularly if it has come from other than the well known groups of forces bordering NATO countries/armies.

2. The method employed to mark unknown or unidentified enemy units on manual, or ADP, map displays is to allocate an *Arbitrary Unit Designator (AUD)*. An arbitrary unit designator is made up of a prefix, a number and a suffix. STANAG 2077 INT contains full details of the method of allocating arbitrary unit designators and a precis of its contents follows for ease of reference.

Prefix

3. A 3 digit alphanumeric distinguishing code indicating the corps originating the AUD (the final dinome indicating nationality as laid down in STANAG 1059)eg:

- 1 (BR) Corps will use 1UK *
- 2 (GE) Corps will use 2GE
- 7 (US) Corps will use 7US

or

4. A 2 letter distinguishing code indicating the NATO formation allocating the AUD. These prefixes are:

SHAPE	SH
AFNORTH	AN
COMMON	NN
COMSONOR	SN
COMBALTAP	BA
COMLANDJUT	JU
COMZEALAND	ZE
AFCENT	AC *
NORTHAG	NG *
CENTAG	CG *
AFSOUTH	AS

* To be reviewed in conjunction with other NATO STANAGS.

LANDSOUTH	LS
LANDSOUTHEAST	SE
AMF(L)	AM

or

5. A 2 letter distinguishing code in accordance with the national distinguishing letters given in ADatP-3 Part IV an extract of which follows:

ALBANIA	AL	LIBYA	LY
ALGERIA	AG	LIECHENSTEIN	LS
AUSTRIA	AU	LUXEMBOURG	LU
BELGIUM	BE	MALTA	MT
BULGARIA	BU	MONACO	MN
CANADA	CA	MOROCCO	MO
CYPRUS	CY	NETHERLANDS	NL
CZECHOSLOVAKIA	CZ	NORWAY	NO
DENMARK	DA	POLAND	PL
EGYPT	EG	PORTUGAL	PO
FINLAND	FI	RUMANIA	RO
FRANCE	FR	USSR	UR *
GERMANY	GE *	SPAIN	SP
GERMANY	GC *	SWEDEN	SW
GIBRALTAR	GI	SWITZERLAND	SZ
GREECE	GR	TUNISIA	TS
GREENLAND	GL	TURKEY	TU
HUNGARY	HU	UNITED KINGDOM	UK
ICELAND	IC	UNITED STATES OF	
IRELAND	EI	AMERICA	US
ITALY	IT	YUGOSLAVIA *	YO

Number

6. National corps will be responsible for allocating blocks of numbers between 000 and 999 to their own headquarters and subordinate formations. Similarly, divisions may sub-allocate numbers to their subordinate formations. All formations of a corps and corps HQ will however use the same prefix. Nations and NATO formation headquarters will use the same block of number ie 000-999.

* To be reviewed in conjunction with other NATO STANAGS.

Suffix

7. The prefix and number will be followed by a suffix indicating:
 - a. The nationality of the enemy formation.
 - b. The type of formation.

Changes in Arbitrary Unit Designator

8. The arbitrary unit designator allocated in accordance with paragraphs 5, 6 and 7 will not normally be changed unless an unidentified enemy unit or formation is recognized separately by 2 formations, each of which allocates its own AUD. Under such circumstances the relevant superior headquarters, having agreed that an unidentified enemy formation or unit is present, will either:

- a. Accept one of the already allotted AUDs, but replace the prefix with its own,

or

- b. Allocate a new AUD. In either case both of the originating formations must be informed.

Example

9. A division of 1 (BE) Corps and a division of 1 (BR) Corps separately detect the presence of an unidentified Russian motor rifle division (MRD) in the area of the inter-corps boundary and each gives it an AUD using the block of numbers allocated to them by their own corps (1BE369 UR MRD and 1UK473 UR MRD respectively). Each corps adopts the AUD allocated by its originating division. HQ NORTHAG agrees that an unidentified Russian MRD is present and decides to retain the BE number but allocates it a NORTHAG prefix. From then on until positively identified, or changed by AFCENT or SHAPE, the unidentified formation will be known as NG369 UR MRD. If for some reason it is changed by AFCENT or SHAPE an AFCENT or SHAPE prefix will be applied. Relevant examples are:

a. 1 (BE) Corps



b. 1 (BR) Corps



c. HQ NORTHAG agree that an unidentified UR MRD is present and retain the BE number but allocate a NORTHAG prefix and inform both corps headquarters of the change:



CHAPTER 3

Terrain and tactical activities

Part 1 Guide to use

0301. Because the symbols listed in this chapter are each used differently, it is necessary to refer to Part 2 to find out precisely how each one is to be used. In Part 2, the symbols are listed under the following paragraphs:

- | | |
|---------------------------------|----------------|
| 1. Points | Paragraph 0303 |
| 2. Military fortifications | Paragraph 0304 |
| 3. NBC events | Paragraph 0305 |
| 4. Lines | Paragraph 0306 |
| 5. Areas and positions | Paragraph 0307 |
| 6. Fire planning symbols | Paragraph 0308 |
| 7. Obstacles | Paragraph 0309 |
| 8. Movement | Paragraph 0310 |
| 9. Mission or Intention Symbols | Paragraph 0311 |

0302. General points

1. *Location of symbols*

a. 'Areas'

Symbols for areas are to be located by one of three ways:

- (1) *To scale* on the map or diagram concerned, following the representation of the area concerned.
- (2) *Schematically drawn* on the map or diagram concerned, with its centre on the area concerned.
- (3) *Schematically drawn and tied by a location vector*, to the centre of the area on the map or diagram concerned, if this will improve clarity.

b. 'Lines'

To follow the grid references of the feature they represent.

c. *‘Movement’*

To follow the grid references for the movement concerned.

d. *‘Obstacles’*

Obstacle symbols should be drawn over the exact grid reference of the obstacles concerned. If this is not possible, the symbol may be drawn elsewhere and connected to the exact grid reference by means of a location vector.

e. *‘Points’*

Point symbols either rest their lower point on the spot concerned, or are tied to it by means of a location vector.

2. *Enemy representation*

When one-colour representation is used, the letters ‘EN’ should be repeated as often as necessary for clarity. Examples are:

a. Enemy area

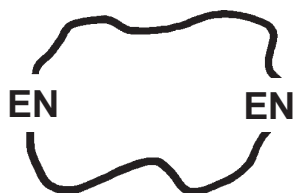

b. Enemy front line

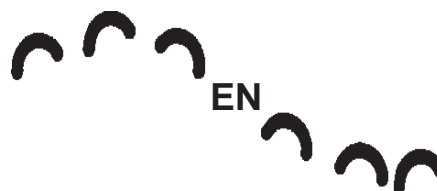

3. *Fields*

The position and used of ‘Fields’ in connection with the symbols given in this chapter differ according to the symbol concerned. They are described in detail in paragraph 0311.

4. *Use in connection with a unit or equipment symbol*

When a unit or equipment symbol is used in conjunction with a symbol from this chapter, it must follow the rules et out in Chapter 2.

5. *Use of query mark*

The query mark may be used when:

- a. Part of the information is unknown. The query mark is to be placed in the field concerned.
- b. Part of the information is doubtful. The query mark is to be placed at the end of the appropriate field.
- c. All information is doubtful or unconfirmed. The query mark is to be placed in field E.

Part 2 Catalogue of symbols

0303.Points

A point of military interest on a map or diagram is indicated by one of the following:

- 1. Contact or unspecified point



A special indicator may be added; the ones most commonly used are:

- a. Starting point



- b. Release point



- c. Check point







- 2. Control point



- 3. Coordinating point. For this symbol, the location point is the *centre* of the symbol



0304. Military fortifications

- 1. Earthwork/small trench/fortification 
- 2. Surface shelter 
- 3. Underground shelter 
- 4. Strong point 

0305. Nuclear biological or chemical events

- 1. Nuclear strikes are indicated as follows:

- a. Actual strikes



- b. Suspected or planned strikes



Enemy suspected future strikes

- 2. Biological and chemical events

- a. To differentiate between them, biological (BIO) or chemical (CHEM) will be written in field V.



- b. If the exact type of contamination is not known, 'NBC' will be written in field V.



d. The diagram below illustrates some of the different cases that may occur:

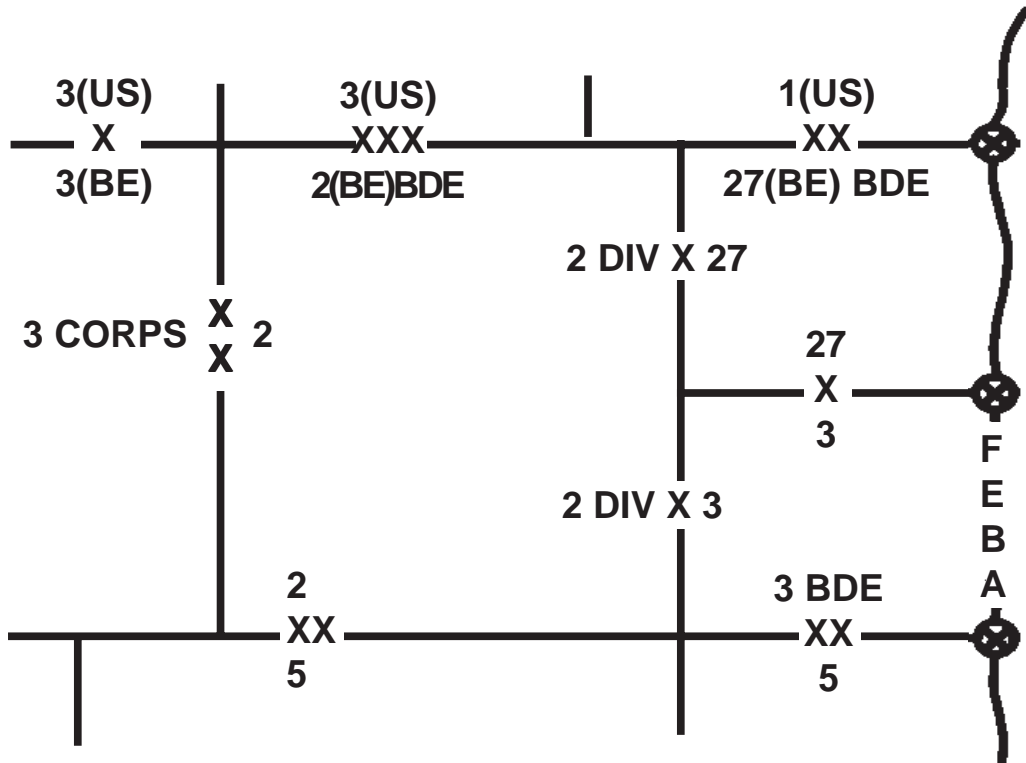

2. Phase lines or coordination lines

a. FEBA

The FEBA is marked by a series of curved lines:



- (1) The position of each curve does not necessarily mark the location of a combat element.
- (2) The convex side of the symbol is towards the enemy.

b. Other phase or coordination lines

(1) These are marked by the normal symbol for a 'Line', with a line indicator and supplementary information at appropriate intervals. Generally they follow grid references or some feature of the terrain.

(2) The following line indicators may be used (shown in alphabetical order):

(a)	Bridgehead	- BRHD
(b)	Communication zone	- COMZ
(c)	Fire support coordination line	- FSCL
(d)	Forward combat zone	- FCZ
(e)	Forward edge of the battle area	- FEBA
(f)	Forward line of enemy troops	- FLET
(g)	Forward line of own troops	- FLOT
(h)	Line of departure/start line	- LD/SL
(i)	Main supply route	- MSR
(j)	No fire line	- NFL
(k)	Objective	- OBJ
(l)	Phase line or coordination line	- PL
(m)	Rear combat zone	- RCZ
(n)	Report line	- RL

(3) Examples are:

(a)

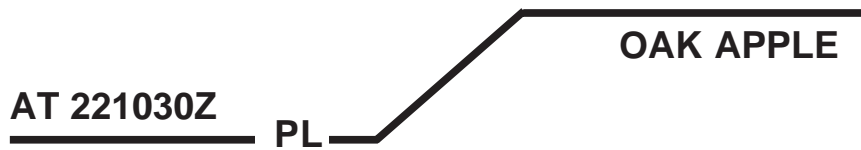

A phase line, nicknamed, 'OAK APPLE' which is to be reached at 1030Z on the 22nd day of the current month

(b) FROM 121500Z TO 121800Z

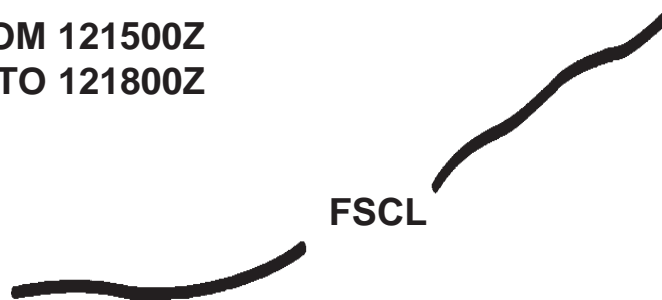

A fire support coordination line, following a terrain feature, effective from 121500Z to 121800Z

(c) AT 221030Z

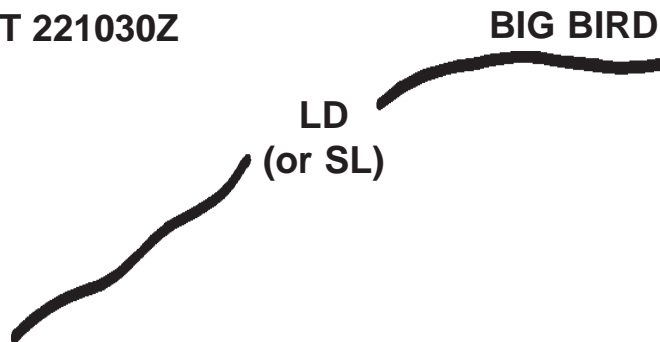

A line of departure/start line, nicknamed 'BIG BIRD', which is to be crossed at 1030Z on the 22nd day of the current month

d. Fortified line

A fortified line is represented by  repeated at appropriate intervals. For example:



e. Routes

See paragraph 0310 - Movements

f. Unspecified obstacle line

An unspecified obstacle line is represented by
at appropriate intervals. For example:

**0307.Areas and positions**

1. a. An area is a delineated portion of terrain or space, having its own features by virtue of its nature or the activities going on within it.
 - b. A position is an area from which it is intended to fight.
 - c. When displaying areas by ADP means, the area is created by a series of grid references joined by straight lines: therefore not less than *three* grid references are required for each area
2. *Areas*
 - a. The layout indicates the difference between the following types of area, which are explained below:
 - (1) Concentric area.
 - (2) Reconnaissance area.
 - (3) Specified area.
 - b. Concentric area
 - (1) This is used to depict radiological contamination.
 - (2) It consists of one or more rings used to make up a concentric area. Each ring consists of a line interrupted by a letter/figure combination.

(3) The minimum safe distances from ground zero of one or more nuclear explosions are shown as follows:

- (a) Minimum safety distance 1 MSD1
- (b) Minimum safety distance 2 MSD2
- (c) Minimum safety distance 3 MSD3

(4) Levels of radioactivity are indicated by the rate in centigrays per hour, thus:



(5) The rings must always be drawn to scale. They may be circular or may not!

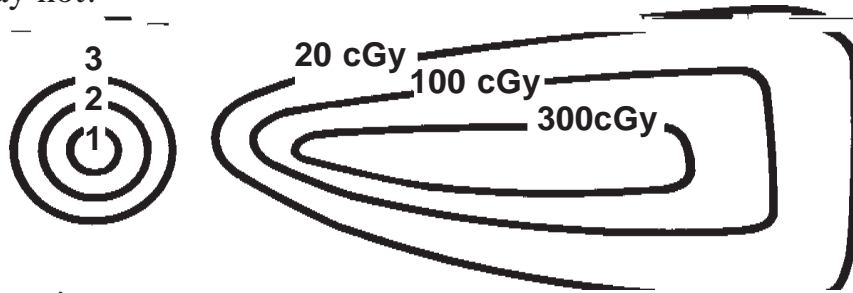

c. *Reconnaissance area*

(1) Used to depict the area within which a unit or formation is responsible for reconnaissance.

(2) The points of the arrows indicate the width of that area but *not* its forward edge:

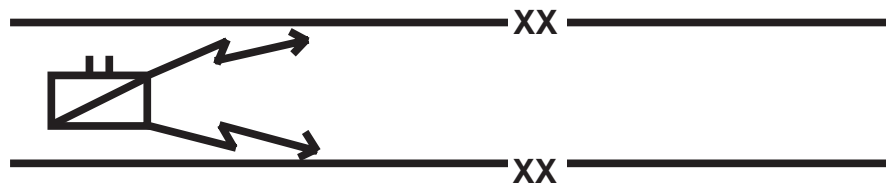

d. *Specified area*

(1) (a) An area assigned to or occupied by a unit for some specific purpose. An example would be a parachute dropping zone.

(b) An area that has been delineated for some specific purpose. An example would be an area of nuclear contamination.

- (2) These are depicted by a *continuous line plus an area indicator*, to denote the type of area represented.
- (3) A symbol depicting any unit or installation assigned to or occupying the area may be added, inside the area or attached to it by a vector.
- (4) The following area indicators may be used to denote the type of area represented:

(a) *Limited access - denoted by wording*

This indicates by words, areas it is inadvisable to enter:

(1) Contaminated biologically	BIO
(2) Contaminated with chemical (that is, persistent agent in liquid or similar form)	CHEM
(3) Contaminated with gas (vapour hazard area)	GAS
(4) Impassable	IMPAS
(5) Inundation	INUND
(6) Minefield	MINE
(7) Obscured by smoke	SMOKE
(8) Radioactive	ATOM
(9) Shelled or bombed	SHELL

(b) *Limited access - denoted by symbols*

(1) This indicates by a basic symbol that the area is impassable.

(2) Superimposed on the basic symbol are other symbols to indicate to what personnel/equipment the area is impassable.

(3) The basic symbol is:



(4) Some examples are:

(a) Impassable to infantry



(b) Impassable to wheeled vehicles



(c) Usage of area

- (1) This indicates the use being made of that area
- (2) The areas most commonly used are listed below. Others may be used, but if they are, they must be explained in a legend.

- (a) Assembly area ASSY
- (b) Concentration CONC
- (c) Drop zone DZ
- (d) Dump DUMP

- (e) Hide area HIDE
- (f) Intermediate objective I/OBJ
- (g) Key terrain KEY
- (h) Landing zone LZ
- (i) Logistic area LOG
- (j) Objective OBJ
- (k) Obscured by SMOKE
- (l) Reserve RES
- (m) Shelled or bombed SHELL
- (n) Unoccupied but prepared for a purpose (to be used in conjunction with one of the other indicators)

e. *Examples*

(1) Limited access denoted by wording - an area contaminated with chemicals (normally shown in yellow).

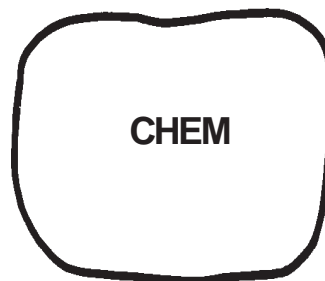

(2) Limited access denoted by a symbol - an area impassable to tracked and wheeled vehicles, symbol outside the area and connected to it by a vector. Mobility indicators for wheeled and tracked vehicles inserted to show for which equipment the area is impassable.

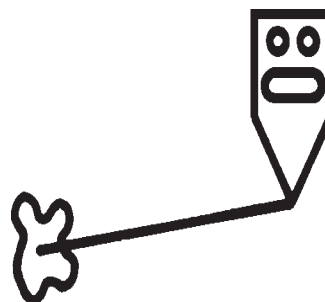

(3) *Usage of area*

(a) An area to be used as an assembly area (ASSY) (broken line indicates future use)



(b) An area being used by 2nd Parachute Battalion as a drop zone (DZ)

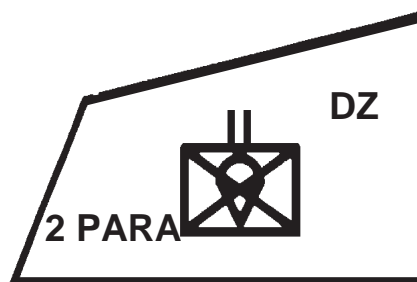

(c) An area prepared for use as a maintenance installation, but not yet occupied.



3. *Unspecified area*

- a. An area of ground that requires to be delineated for any reason, but does not show a specific purpose.
- b. This is depicted by a continuous line enclosing the area in question.
- c. A symbol depicting any unit or installation assigned to or occupying the area may be added; inside the area or attached to it by a vector.
- d. Examples are:

(1) An unspecified area



- (2) An unspecified area occupied by 3rd Infantry Battalion

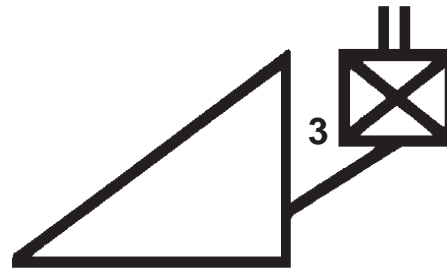

4. *Positions*

- a. (1) A position is an area from which it is intended to fight. It may be drawn to scale (mainly used at lower levels of command) or shown schematically (mainly used at higher levels of command).
- (2) A size indicator is inserted in the line delineating the position, to show that it is a 'Position' and not an 'Area'. This size indicator is to be inserted in the side nearest 'own' troops.
- (3) A symbol depicting any unit or installation that is assigned to, or occupying, the position may be added, inside the position or attached to it by a vector. If desired, just the unique designation maybe shown, but in this case, it must always match the size indicator inserted in the line.
- (4) *Entrance to a position.* Friendly troops should enter a position on the side away from the expected enemy advance. Entrance to a position is identified by placing the unit size symbol on the appropriate side of the position symbol.
- (5) The following types of positions may be shown:
- (a) Combat position.
 - (b) Firing position.
 - (c) Strong point.
- b. *Combat position*
- (1) An area from which a unit intends to fight temporarily and which is not well fortified.

(2) Drawn to scale

Combat position occupied by 2nd Battalion, The Chasseurs (2 Ch). Unique designation used with size indicator

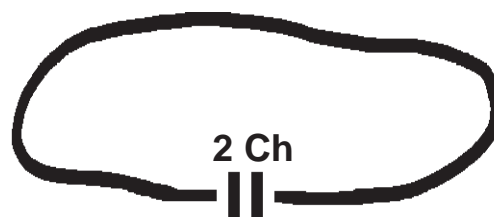

(Own troops this way)

c. *Firing position*

(1) To be used in conjunction with a unit or an equipment symbol. To be orientated in the direction of firing.

(2) *Drawn to scale*

(a) Firing position occupied by B Squadron; position follows a line such as a terrain feature.

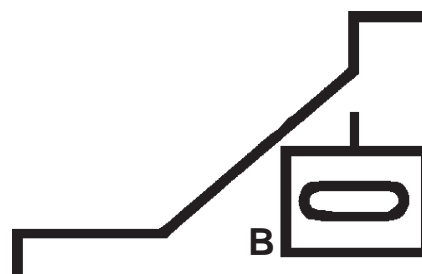

(b) Firing position occupied by two heavy anti-tank guns

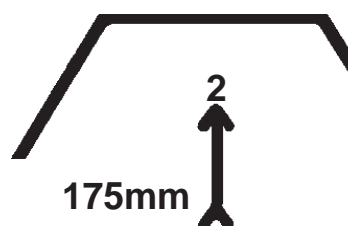

(3) *Schematic*

Firing position occupied by 13th Battalion, Light Infantry (13LI)

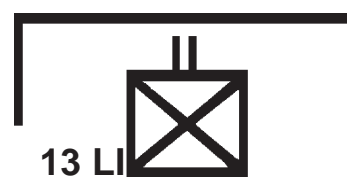

d. *Strong point*

- (1) A well fortified position, usually of a defensive nature.
- (2) *Drawn to scale*

(a) A strong point occupied by B Company

(Own troops this way)

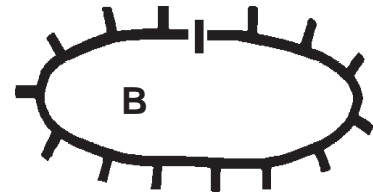

(b) A strong point to be occupied by an enemy tank battalion. Broken line shows future intention, size indicator shows direction of enemy's own troops. In one colour representation, 'EN' displayed at intervals.

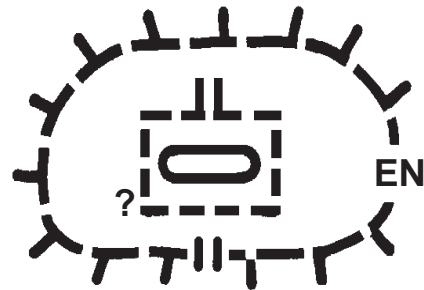

(Enemy's own troops this way)

(3) *Schematic*

A strong point, occupied by the 1st Battalion, the Duke of Wellington's Regiment (1DWR), symbol attached by a vector, given the codeword 'HOOK'.

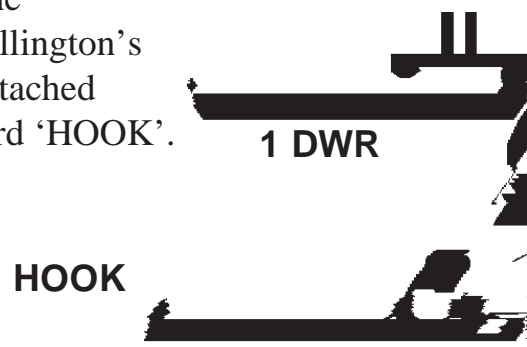

(Own troops this way)

0308. Fire-planning symbols

1. *Concentration point*



2. *Linear concentration*



3. *Nuclear target (point)*

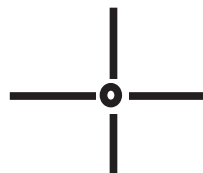

4. *Arc of fire*

- a. Broken lines should be used to indicate a proposed arc and solid lines to depict current status.
- b. If required, a ‘hook’ may be added at the end of the arc to indicate the maximum effective range of the weapon in that position.
- c. Examples are:

(1) Proposed arc of fire from the location point of an equipment symbol



(2) Proposed arc of fire from the sides of a firing position. The optional ‘hook’ has been added to show the maximum effective range from this position (some obstruction limits the range on the right).

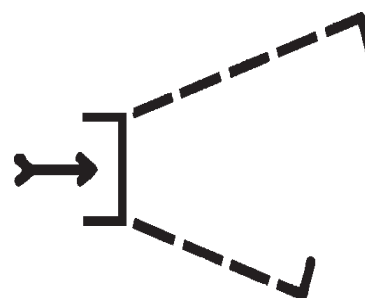

(3) Arc of fire from the sides of an artillery battalion position. Solid lines used to indicate the arc for clarity.

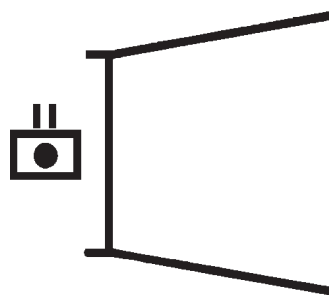

0309. Obstacles

1. Obstacles are divided into two categories as follows:

a. *Point obstacles*, which use the following basic symbol, with an indicator superimposed to show the state:

(1) Friendly



(2) Enemy



b. *Linear obstacles*, which follow the shape of the obstacle.

(1) Linear obstacles will be identified normally by the actual outline of the obstacle being drawn to scale on the map or overlay.





(2) A minefield or anti-tank ditch will normally be drawn to scale at the precise location of the obstacle. Where this is not possible, a rectangle should be drawn away from the location and connected to it by a location vector.

2. The following types of obstacle may be shown:

- a. Point obstacles.
- b. Demolitions.
- c. Linear obstacles.
- d. Minefields.





(For symbols depicting the crossing of an obstacle, see paragraph 0310 - Movements).

3. The following obstacle indicators can be superimposed on either point or linear obstacle symbols:

- a. Abatis or tree blowdown. 
- b. Booby trap. 
- c. Non-explosive anti-tank obstacle. 
- d. Trip wire. 

4. *Demolitions*

- a. The symbol should be drawn over the precise grid reference of the obstacle, but where this is not possible, the symbol may be drawn away from the grid reference and connected to it by a vector.
- b. The following demolition indicators will be used to show the status of the obstacle:

- (1) A planned point target 
- (2) Prepared demolition State 1 (Safe) 
- (3) Prepared demolition State 2 (Armed) 
- (4) Executed or fired 

- c. If there is no need to distinguish between State 1 (Safe) and State 2 (Armed) or if the state is unknown, the symbol for State 2 will be used.
- d. If there is a need to show that the demolition is 'Reserved', the word 'RESERVED' should be written in field H (free text), if possible with the target number or target nickname shown in field T (unique designation).
- e. *Example:* A reserved bridge demolition, target number B32, which is at State 2, drawn away from the grid reference and connected to it by a location vector.



5. *Linear obstacles*

a. *Anti-tank ditch*

- (1) A line with  repeated at intervals,  indicates under preparation,  indicates completed.

- (2) *Example.* A completed anti-tank ditch (drawn away from the location and connected by a vector):



b. *Wire obstacles*

- (1) A line with 'X' repeated at intervals. If the obstacle is under preparation, a broken line will be used. If an enemy obstacle 'EN' will be shown at intervals.

- (2) *Example.* An enemy wire obstacle under preparation (following the actual line on the ground).

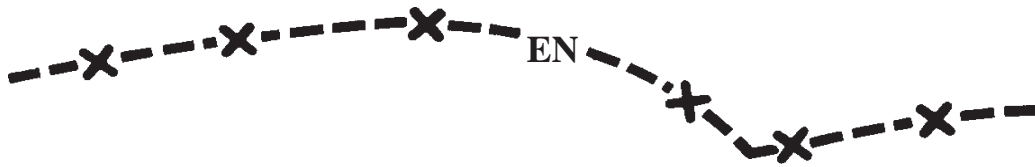

c. *Unspecified linear obstacle*



6. *Minefields*

a. The following mine indicators will be used:

(1) Anti-personnel mine



(2) Anti-tank mine



(3) Anti-tank mine with anti-handling device



(4) Directional mine (arrow points in direction of main effect)



(5) Mine cluster



(6) Mine, type unspecified



(7) Scatterable mines:

(a) The letter 'S' above the symbol means the minefield has been laid with scatterable mines.

(b) The letters '+S' above the symbol means the minefield has been thickened with scatterable mines.

b. *Nuisance minefield*

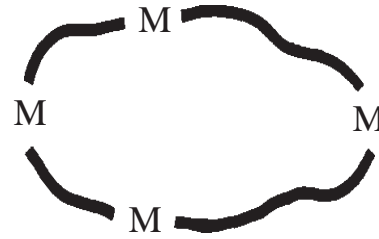

c. *Phoney minefield*

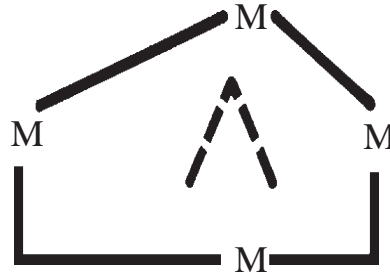

d. *Protective minefield*



(Laid with anti-tank mines)

e. Tactical minefield

(1) *Drawn to scale*

A completed minefield,
type of mine unspecified



(2) *Schematic*

A completed anti-tank
minefield (drawn away
from the location and
connected by a vector)

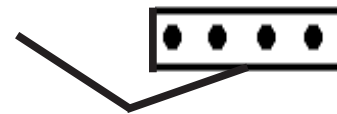

(3) *Scatterable Mines*

(a) A completed
scatterable anti-tank
mine

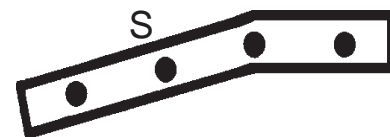

- (b) Planned anti-tank minefield thickened with scatterable mines

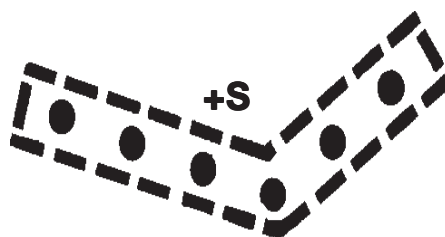

0310. Movements

1. *Air movement*

- a. The basic symbol for a route is used with the symbol for Air Force or army aviation repeated at convenient intervals, to show who is using it.
- b. Examples are:
 - (1) A one-direction route used by the Air Force



- (2) A two-direction route that army aviation plan to use

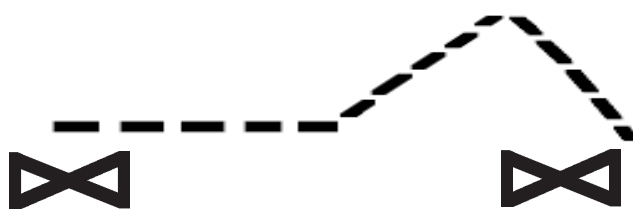

(See Symbol No 8 at Page 2-19)

2. *Bridge or gap in an obstacle*

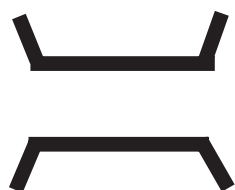

3. *Delaying action*

The symbol should follow the centre line of the route to be used, the double bars indicate delaying actions to be undertaken, but not necessarily the location of those actions or number:

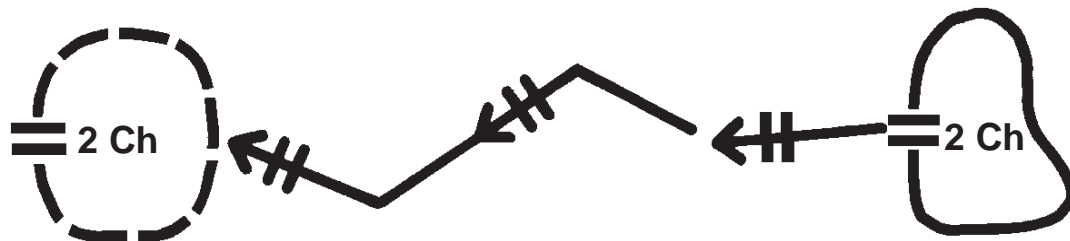

(The example given shows 2nd Battalion, The Chasseurs (2 Ch) moving from a combat position on the right to a future position on the left and due to undertake delaying actions)

4. *Directions*

- a. (1) Broken lines indicate future movement.
- (2) Designations, such as unit symbols or code names, are optional.
- (3) Control measures such as boundaries maybe included.
- b. *Routes*

In land warfare, a specified direction or course which the movement will follow:



(Should mark the precise route, arrow at head only)

c. *Axis*

In land warfare, a general description, verbal or graphic, of the direction which movement will take (broken lines) or has taken (solid lines):

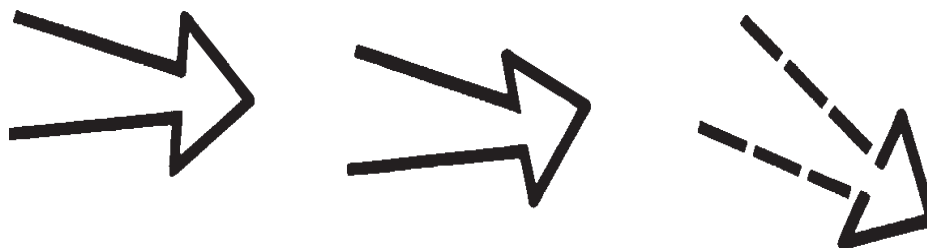

(see paragraphs 0203.2 and 0312.10)

5. *Ferry*



6. *Minefield lane*



7. *Reconnaissance*

The symbol should follow the centre line of the route to be used:



8. *Route*

- a. The arrows show the direction of movement and should be repeated as often as necessary for clarity.
- b. If movement in both directions is allowed, no arrows should be shown.
- c. If the route has a codeword and/or a military load classification (MLC), it may be written beside the route at convenient intervals.

d. Some examples are:

(1) Route, with MLC of 60, movement in one direction only



(2) Enemy route, codeword KING, movement in both directions, one-colour representation used



(3) Own planned route, codeword QUEEN, MLC 30, movement in one direction only



0311. Mission or Intention Symbols



The axis of advance symbol shows the intention to attack



A double arrowhead identifies the main attack

0312. Fields for symbols

1. a. Detailed information on the purpose and layout of fields is given in paragraph 0108.
- b. As each of the main types of basic symbol described in this chapter require a different display of information, it is necessary to have a separate field diagram for each type: however, wherever possible, the layout and titles of fields remain the same.

2. Diagrams of fields

In the diagrams set out below, only the fields most likely to be used, are shown.

a. *Points*



b. *Military fortifications*



c. NBC events

(1) Nuclear

C=Yield
 Q=Downwind direction
 T=Delivery unit
 V=Weapon type

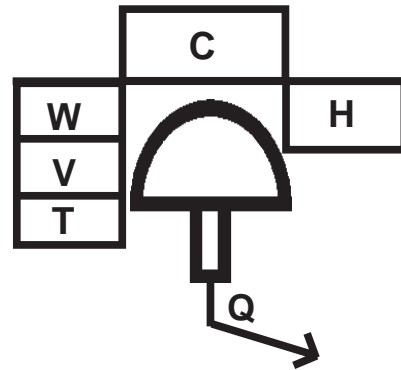

(2) Biological

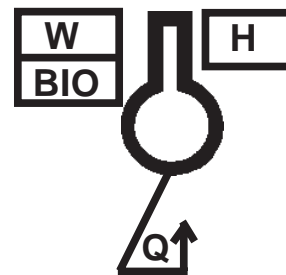

(3) Chemical

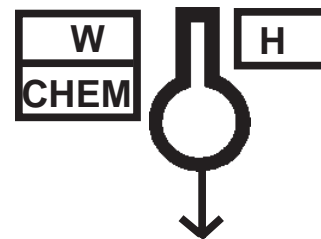

d. Lines

(1) Phase lines/coordination lines

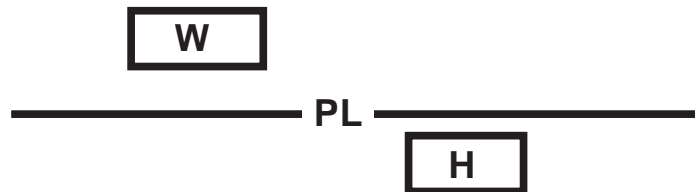

(2) Boundaries

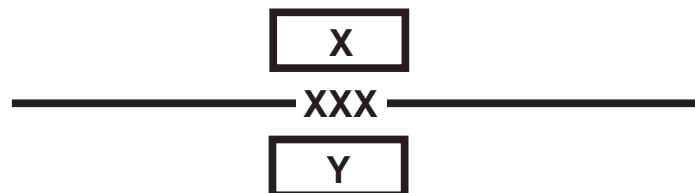

X and Y = Unit names

e. *Areas*

(1) *Concentric Area*

(a) *Minimum safety distance*

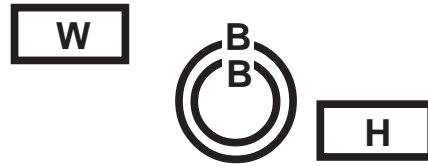

B = Radiation value

(b) *Levels of radioactivity*

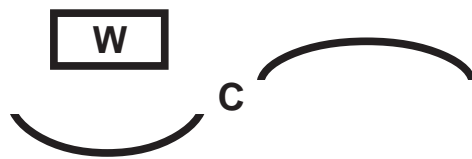

C = Level of radioactivity

(2) *Specified area*

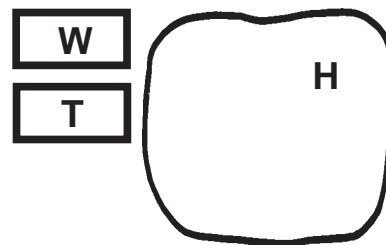

H = Usage of area

(3) *Unspecified area*

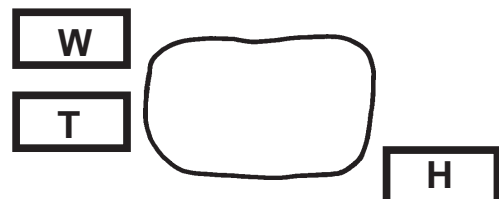

f. *Positions*

(1) *Combat position*

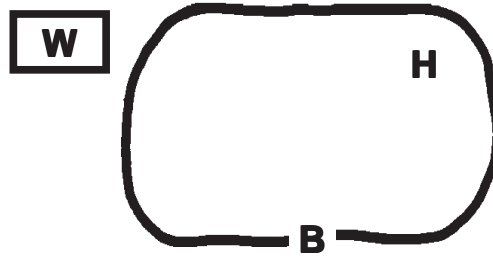

H = Usage of area

Note: Field B (size indicator) to be shown on the side nearest own troops

(2) *Strong point*

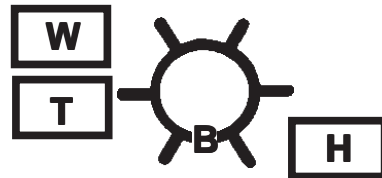

Note: Field B (size indicator) to be shown on the side nearest own troops

g. *Fire planning symbols*

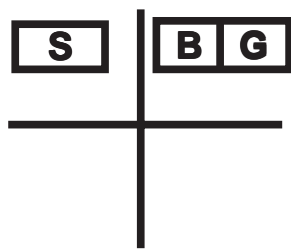

OR

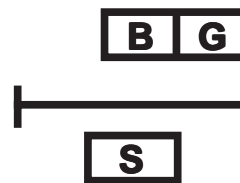

B = Target number G = Priority
S = Time 'From/To' indicator

h. *Obstacles*

(1) *Point Obstacle*



(2) *Linear obstacle*



i. *Movements*

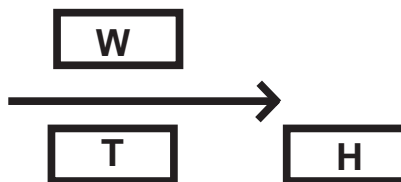

3. Where the 'Applicable to' column in the table in paragraphs 0312.4 shows 'All', this means applicable to the basic symbols for:

- a. Points.
- b. Military fortifications.
- c. NBC events.
- d. Lines.
- e. Areas and positions.
- f. Fire planning symbols.
- g. Obstacles.
- h. Movements.

4. Contents of mandatory information fields

Field letter	Maximum field	Title and description length	Applicable to	Remarks
(a)	(b)	(c)	(d)	(e)
A	-	<i>Identifier indicator</i> The basic symbol	All	-
B	6	<i>Size indicator</i>	Some areas Boundaries	
	6	<i>Target number</i> Target number to be shown for concentrations	Fire planning	
	6	<i>Level of radio-activity or Minimum safety distance</i>	Circular or or elongated areas	Usually activity associated with nuclear events
C	6	<i>Yield</i> Shown in kilotons (KT) or megatons (MT)	Nuclear events 'KT' or 'MT'	Shown as a figure (which may include a decimal point) followed by
G	17	<i>Additional information</i> For notes by the user	All	The contents of this field may not necessarily be transmitted to other users
	17	<i>Priority indicator</i> For use with a linear concentration	Fire planning	Must be transmitted
H	15	<i>Free text</i> Space for additional	All	Important information,

Field letter	Maximum field	Title and description length	Applicable to	Remarks
(a)	(b)	(c)	(d)	(e)
		information not covered by the other fields	to be transmitted	which should be in this field <i>not</i> in field G
	15	<i>Area usage</i> (See paragraph 0307.2d(4))	Areas	-
	15	<i>Height of burst</i> Shows height of burst above the surface in km, or as 'AIR' or 'SURFACE'	Nuclear events	Shown as a figure followed by 'KM'; or as 'AIR' if height not known or 'SURFACE' if weapon explodes on surface
Q	-	<i>Downwind direction.</i> Shows likely direction of any radioactive fall-out, biological or chemical downwind hazard	NBC events	a. Positioned from the location point. b. The arrow indicating the downwind direction may be supplemented by other data taken from an NBC-3 (NUC) or an NBC-3(CHEM) message

Field letter	Maximum field	Title and description length	Applicable to	Remarks
(a)	(b)	(c)	(d)	(e)
T	15	a. <i>Unit name</i> or or unique designator b. <i>Delivery unit</i>	Strongpoints Obstacles Areas Nuclear events	and shown in the appropriate fields; for ex- ample, 'Time' in field W and 'Designation' in field T
V	15	<i>Weapon types</i> Shown as EXA - outside the atmosphere	Nuclear events	Shown as a 5 character alphanumeric field incor- porating 'EXA'
W	15	<i>Date/Time group</i> Preceded by a qualifier either 'TO' or 'FROM'	All, less boundaries	7 character alphanumeric field for date/time, preceded by up to 7 letters to show 'TO'
X and Y	15	Unit name The unique number or the abbreviated title of the unit	Boundaries	Different name will appear on each side of the boundary, hence 2 fields

Part 3 Examples of symbols

0313.

1. Points

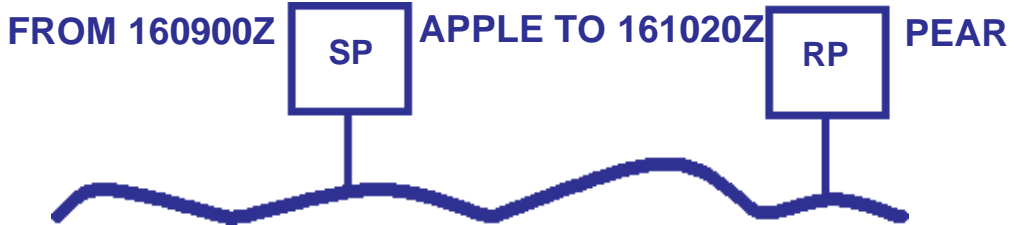

Start and Release points at APPLE and PEAR. Start point from 160900Z and Release point until 161020Z

2. Military fortifications



An underground shelter, codeword 'OAK', to be ready by 191320Z

3. NBC events

a. Nuclear

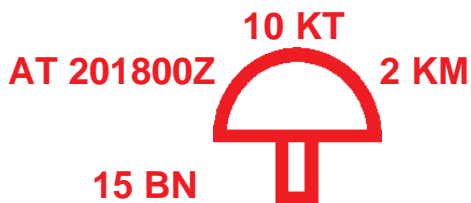

A nuclear strike at 201800Z at an airburst height of 2 km, yield 10 KT, delivery unit 15 Battalion (15 BN)

b. Chemical

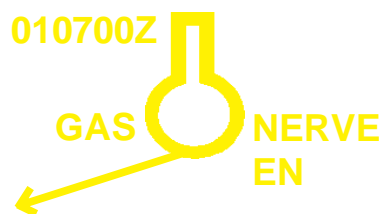

Enemy gas cloud (nerve) agent travelling in the direction of the arrow. Information received at 010700Z

4. Lines

a.

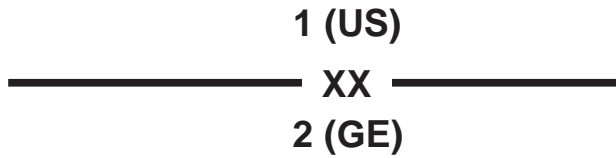

Boundary line between 1st US Division and 2nd GE Division

b.



FEBA nicknamed LONG WALL at 101400Z

c.



Fire support coordination line (FSCL) effective from 121500Z to 121800Z

5. Areas and positions

a. Concentric area

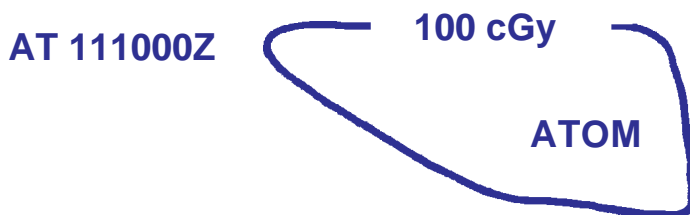

An area with radiation contamination of 100 cGy at 111000Z

b. Reconnaissance area



Battalion responsible for reconnaissance of the whole area in front of the FEBA, within the boundaries shown

c. Specified area

FROM 031000Z



15 (US) COY

Ammunition dump effective from 031000Z, manned by 15 (US) Company

d. Unspecified area

UNTIL
042300Z



An area in which 16 Infantry Battalion are resting until 042300Z

e. Combat position



Combat position, drawn to scale, occupied by A Company, own troops in direction indicated by the size indicator

f. Strong point

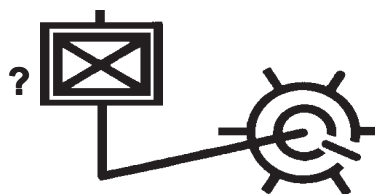

Enemy strong point, schematic, occupied by an Infantry Company (which one not known), their own troops in direction indicated by the size indicator

6. Fire planning symbols

a.

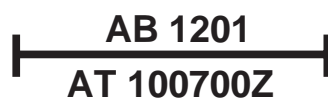

A linear concentration, target number AB1201, on a target effective at 100700Z

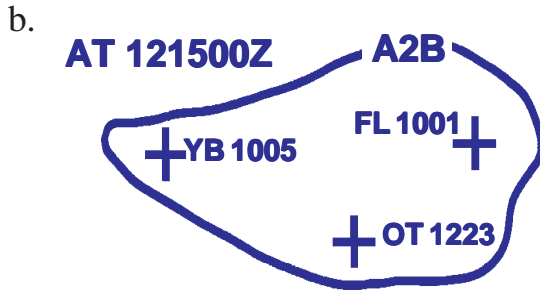

A group of targets, under the code name A2B effective at 121500Z

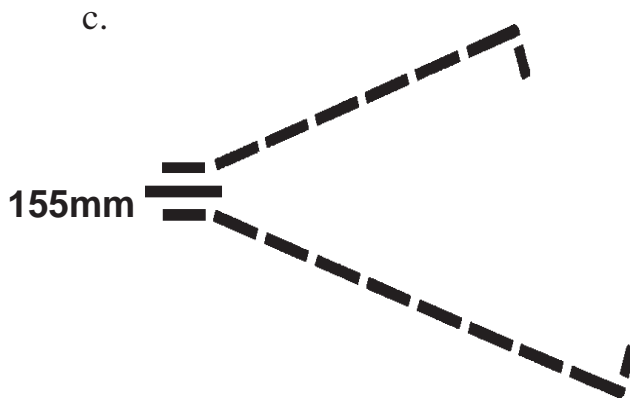

A medium gun with its arc of fire, maximum effective range from that position shown by the optional 'hooks', site of gun is at the centre bottom of the symbol.
Arcs may be shown as solid lines if required

7. Obstacles

a. Point obstacles and demolitions



Planned abatis reinforced with anti-personnel mines



Executed or fired demolition reinforced with anti-tank mines



Booby-trapped non-explosive anti-tank obstacle, made by the enemy. Information at 021000Z, given the unique designation SHAMROCK

b. Linear obstacles



Completed anti-tank ditch reinforced with anti-tank mines

c. Minefields

(1)



Demolished cross-roads surrounded by nuisance mines

(2)

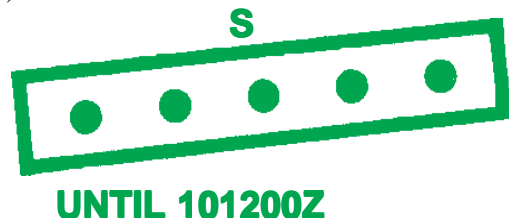

Tactical minefield (drawn to scale) of scatterable anti-tank mines effective until 101200Z

(3)

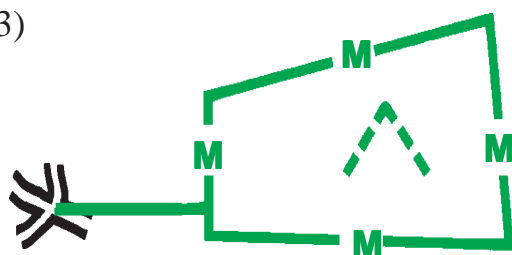

Phoney minefield at a cross-roads (symbol offset and connected by a location vector)

(4)

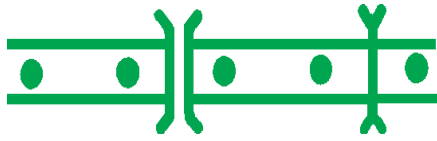

Conventionally laid anti-tank minefield with gap suitable for heavy vehicles, and lane for infantry. Minefield (but not gap) drawn to scale

8. *Movements*

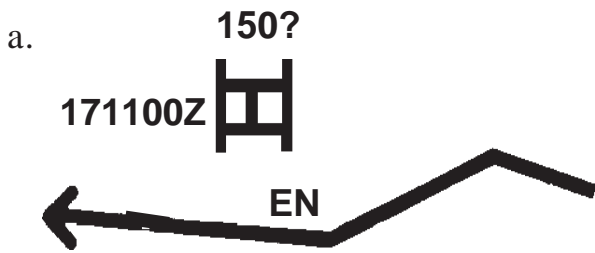

150? enemy tanks spotted at 171100Z moving along the route indicated



An infantry company (A Company) doing a reconnaissance towards a bridge

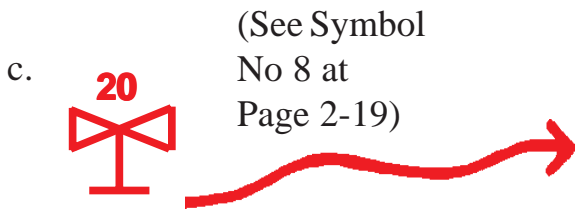

20 enemy army aviation helicopters flying along the route indicated

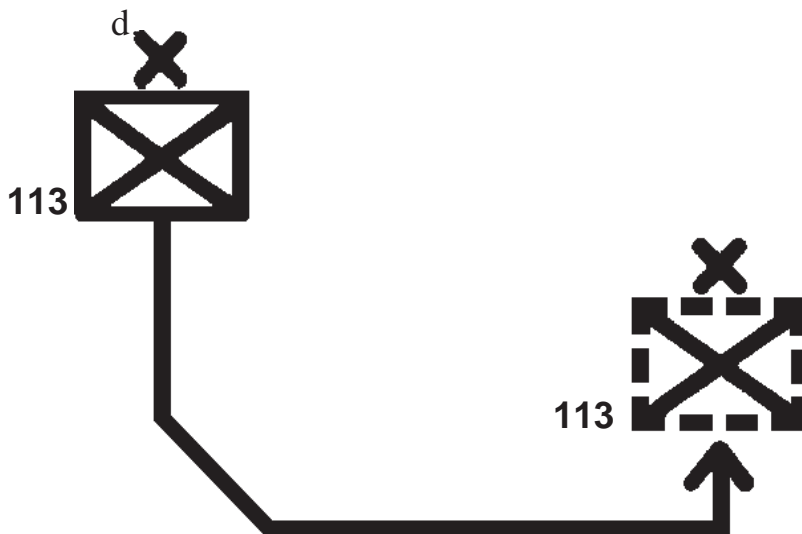

113 Infantry Brigade moving to a new location. The line indicates the approximate route to be followed

e.

FROM 101430Z
TO 101500Z

RAVEN

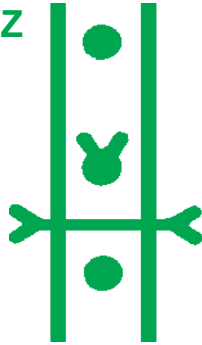

A minefield lane, codeword RAVEN, effective from 101430Z to 101500Z in a minefield laid with anti-personnel and anti-tank mines

9. Attack route

The attack route to be taken by A Company, 1st Battalion, Royal Irish Rangers, at 271430Z. (Shows the precise course the movement is to take)



10. Axis

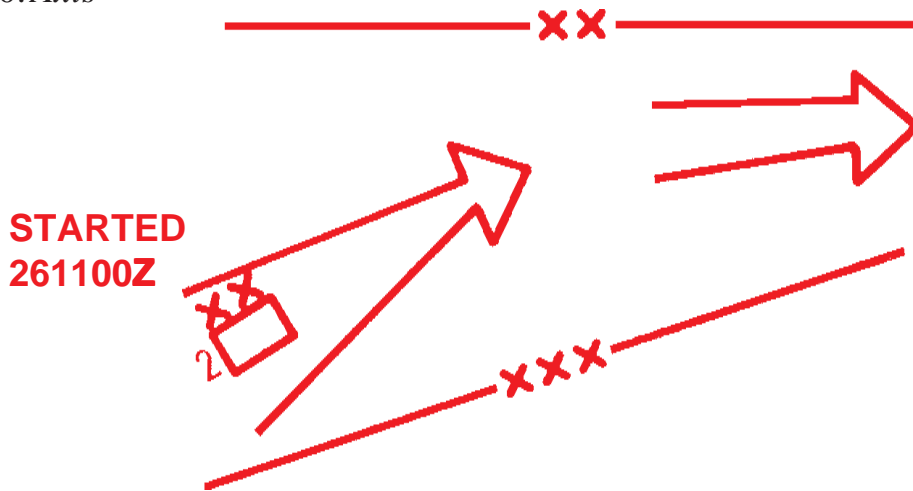

Axis followed by 2 Division which started to move at 261100Z. Boundaries have limited the freedom to manoeuvre.

CHAPTER 4

Automated displays - display rules and information content

0401.

1. *Orientation of symbols.* The following shall have only a vertical orientation:

Units, HQs, Logistic and electronic installations,
Observation posts

Points

Obstacles

Equipments (Note: No implied arc of fire indication for weapons)

2. The following shall have complete freedom of orientation:

All line representations (boundaries, routes)

Minefields, crossings in representation form

Linear and rectangular concentrations

Direction-of-movement arrows

Axis

Crossing indicators (straight form)

0402.

1. *Relative proportions of symbols.* The elements comprising the following symbols adhere to the sizes portrayed in APP-6 in relative proportions:

Units, HQs, logistic and electronic installations,
Observation posts

Nuclear events

Obstacle indicators

Points

0403.

1. *Field locations.* Fields surrounding symbols are to be located as closely as possible to the positions shown in the relevant parts of APP-6. However, fields that lie beside a symbol may require a greater vertical dimension than the symbol they amplify. In this latter case, the top field is to be level with the top of the symbol envelope and lower fields may extend below the level of the symbol.

CHAPTER 5

Glossary of terms for use with APP-6

0501. Symbols

1. *Military symbol*

A graphic sign used, usually on a map, display or diagram to represent a particular military unit, installation, activity or other item of military interest (APP-6). It may be in colour and is normally accompanied by alphanumeric characters
2. *Symbol element*

A part of a military symbol that, with other parts, make up a complete military symbol
3. *Indicator*

A symbol element that further describes the item represented. An indicator can be symbolic or alphanumeric in form
4. *Point indicator*

A symbolic representation of something at a point on a map
5. *Line indicator*

A symbolic representation of something along a line on a map
6. *Area indicator*

A symbolic representation of something over an area on a map

0502. Fields

- | | |
|-----------------------------|--|
| 1. <i>Field</i> | A set position about the basic symbol where further information must or may be displayed |
| 2. <i>Mandatory Field</i> | A field that must always have something in it |
| 3. <i>Conditional field</i> | A field that must have something in it under certain conditions. When the specified conditions are not applicable it is optional |
| 4. <i>Optional field</i> | A field that need not always have something in it. It may be left blank |

0503. Field titles

Field letter shown after title

- | | |
|--|--|
| 1. <i>Role indicator (A)</i> | The symbol element that describes the role, it may be a composite of two or more types |
| 2. <i>Size indicator (B)</i> | The symbol element that indicates the size of the item displayed |
| 3. <i>Quantity of equipment (C)</i> | The symbol element that indicates the number of items displayed |
| 3. <i>Special indicator (D)</i>
veat | The symbol element that indicates a ca-
to the size indicator |
| 5. <i>Unconfirmed, or query mark (E)</i> | The symbol element that indicates that <i>all</i> the information displayed is unconfirmed or doubtful |
| 6. <i>Reinforced, or detached (F)</i> | The symbol element that indicates whether the size indicator is substantially reinforced or reduced |

7. *Additional information* (G) A space beside the symbol that can be used for making notes. Information recorded here is not necessarily forwarded by ADP
8. *Free text* (H) The symbol element that allows additional information to be recorded *and transmitted*
9. *Evaluation rating* (J) The symbol element that shows the source and grading of the information displayed. The gradings are set out in STANAG 2022
10. *Combat effectiveness*(K) The symbol element that indicates the effectiveness of the unit or formation (friendly or enemy) displayed
11. *Signature equipment* (L) The symbol element that warns if an equipment is liable to emit a clearly recognizable signal
12. *Higher formation* (M) The symbol element that lists, if required, some *or* all of the units/ formations senior to the one displayed. These must be shown in strict order of seniority
13. *Enemy* (N) The symbol element that indicates a symbol is 'Enemy' if colour representation or double lines are not used
14. *Arbitrary unit designator* (P) A number, letters or combination of both used to designate a unit or formation whose correct title is unknown.
15. *Direction-of-movement arrow* (Q) A pictorial representation of the direction in which the symbol is moving or will move

16. *Mobility indicator* (R) A pictorial representation of the various types of mobility, wheels, tracks, etc
17. *Headquarters representation* (S) The symbol element that indicates what type or portion of a headquarters is being displayed
18. *Unique designation* (T) The symbol element that uniquely identifies a particular symbol. If a size indicator is shown, it must match it
19. *Name of unit or type of equipment* (V) The symbol element that shows the class or type of the unit, installation or equipment, rather than its unique designation
20. *Date time group* (W)
- a. The symbol element that contains all information relating to time
 - b. A 7 character group comprising 6 numeric characters followed by one alphabetic character, denoting date, time and time zone
 - c. Preceded by space for a further 7 characters to show 'FROM' or 'TO', etc
 - d. Repeated twice to allow for 'FROM/TO' or similar entries
21. *Location point* (-) A place on each symbol used to position positively and accurately that symbol on the map, display or diagram
The position of the location point may vary according to the type of ADP system being used
22. *Location vector* (-) A line joining the location point of a symbol to the following:

a. *For symbols at a point indicator* to the point on the map where the item the symbol represents is located; used when there would be too many symbols near the point for each to be correctly located

b. *For symbols associated with a line indicator* to the line representation

c. *For symbols associated with an area indicator* to the boundary line or a specific point within it

List of effective pages

Effective pages	Page numbers (RB = Reverse Blank)	Effective pages	Page numbers (RB = Reverse Blank)
ORIGINAL	I to IX	CHANGE 2	3-28 to 3-30
CHANGE 2	XI	CHANGE 3	3-31
CHANGE 3	XII	CHANGE 2	3-32 to 3-34
CHANGE 3	1-1 to 1-3	CHANGE 3	3-35 to 3-37
CHANGE 2	1-4 to 1-7	CHANGE 2	3-38 to 3-39
CHANGE 3	1-8	CHANGE 3	3-40
CHANGE 2	1-9	CHANGE 2	3-41 (RB)
CHANGE 3	1-10 to 1-11	CHANGE 2	4-1 to 4-2
CHANGE 2	1-12 to 1-13 (RB)	CHANGE 2	5-1 to 5-5 (RB)
CHANGE 2	2-1 to 2-8	CHANGE 3	LEP-1
CHANGE 3	2-9		
CHANGE 2	2-10 to 2-13		
CHANGE 3	2-14		
CHANGE 2	2-15		
CHANGE 3	2-16		
CHANGE 2	2-17 to 2-18		
CHANGE 3	2-19 to 2-20		
CHANGE 2	2-21		
CHANGE 3	2-22 to 2-24		
CHANGE 2	2-25 to 2-30		
CHANGE 3	2-31 to 2-36		
CHANGE 2	2-37		
CHANGE 3	2-38		
CHANGE 2	2-39 to 2-45 (RB)		
CHANGE 3	2-A-1 to 2-A-2		
CHANGE 2	2-A-3 to 2-A-4		
CHANGE 3	3-1		
CHANGE 2	3-2		
CHANGE 3	3-3		
CHANGE 2	3-4		
CHANGE 3	3-5		
CHANGE 2	3-6 to 3-12		
CHANGE 3	3-13 to 3-14		
CHANGE 2	3-15 to 3-23		
CHANGE 3	3-24		
CHANGE 2	3-25 to 3-26		
CHANGE 3	3-27		