

# Hello, "Darling"

## A 1626 Triode Single-Ended Stereo Amp

by Bob Danielak

**3/4 watts of CHEAP FUN!**

### Introduction

I've been doing tube amps for some time now (over 15 years if you count guitar amps). Over the past several years I've gravitated more and more toward designing/building "HI-FI" type equipment. At the risk of sounding like I'm jumping on the bandwagon, my main interest these days is in relatively low power Single Ended Triode amplifiers.

However, now that these types of amplifiers are practically "mainstream," I may sometimes purposely avoid otherwise great sounding tubes and circuits because others have already "been there - done that". The high price of most popular Directly Heated Triodes and quality output transformers is also an inducement to stay off the main road.

Luckily, if he keeps an open mind, with a little research, experimenting, and junk-box digging the avid DIY'er can end up with a very satisfying piece of equipment and still pay his mortgage.

### About the 1626

Okay. The 1626 is *not* a directly heated triode (DHT). It is an indirectly heated power triode originally used in low power RF amps. It is not the most linear of triodes, and its plate is only rated for about 250V/25mA. Another mild pain is that it requires a 12.6V filament supply (there's no 6.3V connection option). Amplification Factor is about 5. Plate resistance is around 2K.

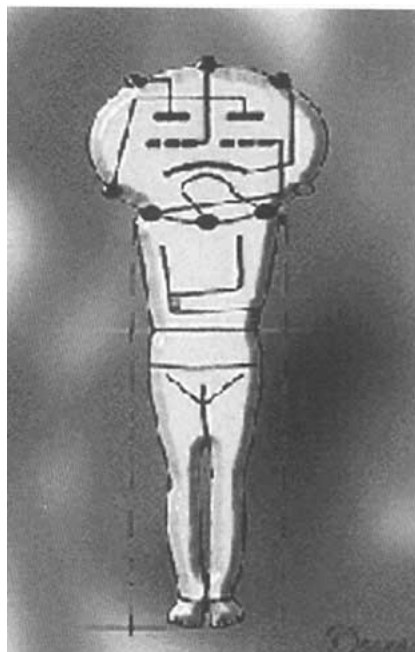

On paper, the 1626 would not appear to be very promising for a Class A audio amp. What really attracted me to this tube, however, was its cute ST-12 shaped bottle. So I picked a few out of a pile of old tubes at some surplus joint for \$2.50 a pop. I was thinking about doing a funky line stage with them.

Of course they sat on a shelf for a while as I worked on several other projects. One of these projects just happened to be a SE 12V6 stereo amp using a 12SJ7 pentode

driver. Somehow, I figured out that the pinout of the 1626 is basically the same as the 12V6 minus the screen connection. So I just dusted off the 1626's and plugged them in.

I was pleasantly surprised with both the sound quality and with the apparent volume I achieved with only 3/4 watt of power. At this point I decided to devote some time to find a good driver for the 1626. Driving the 1626 is not as tricky as it is with other triodes such as the 2A3, 45, or 71A. Biased near its maximum ratings, we only need about 25 to 28V, peak grid voltage. The 1626's input capacitance is also rather low for a triode (around 30pF including Miller Effect). This means we don't need a super-high-current driver.

Any designer worth his salt ought to be able to bark out a dozen worthy candidates for this job. A gain of 20-30, drawing a couple of mA....easy, right?! The biggest problem was that there were too many choices!

Before settling on any one driver I tried a whole slew of tubes/topologies. Just to name a few in descending order of preference: SRPP 12SL7, 12SJ7 pentode, SRPP 12SN7, simple plate loaded 12SL7, Parallel 12SL7, etc, etc.... I never got around to some of my favorite 9-pin triodes like the 12AY7 or 5965/12AV7. I have a feeling that the 5965 would be a good match for this application.

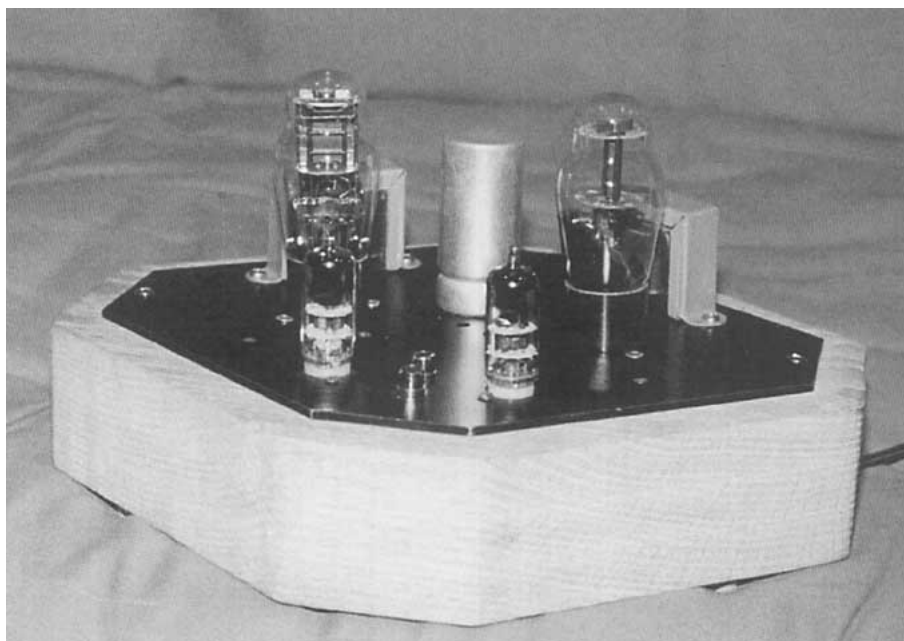

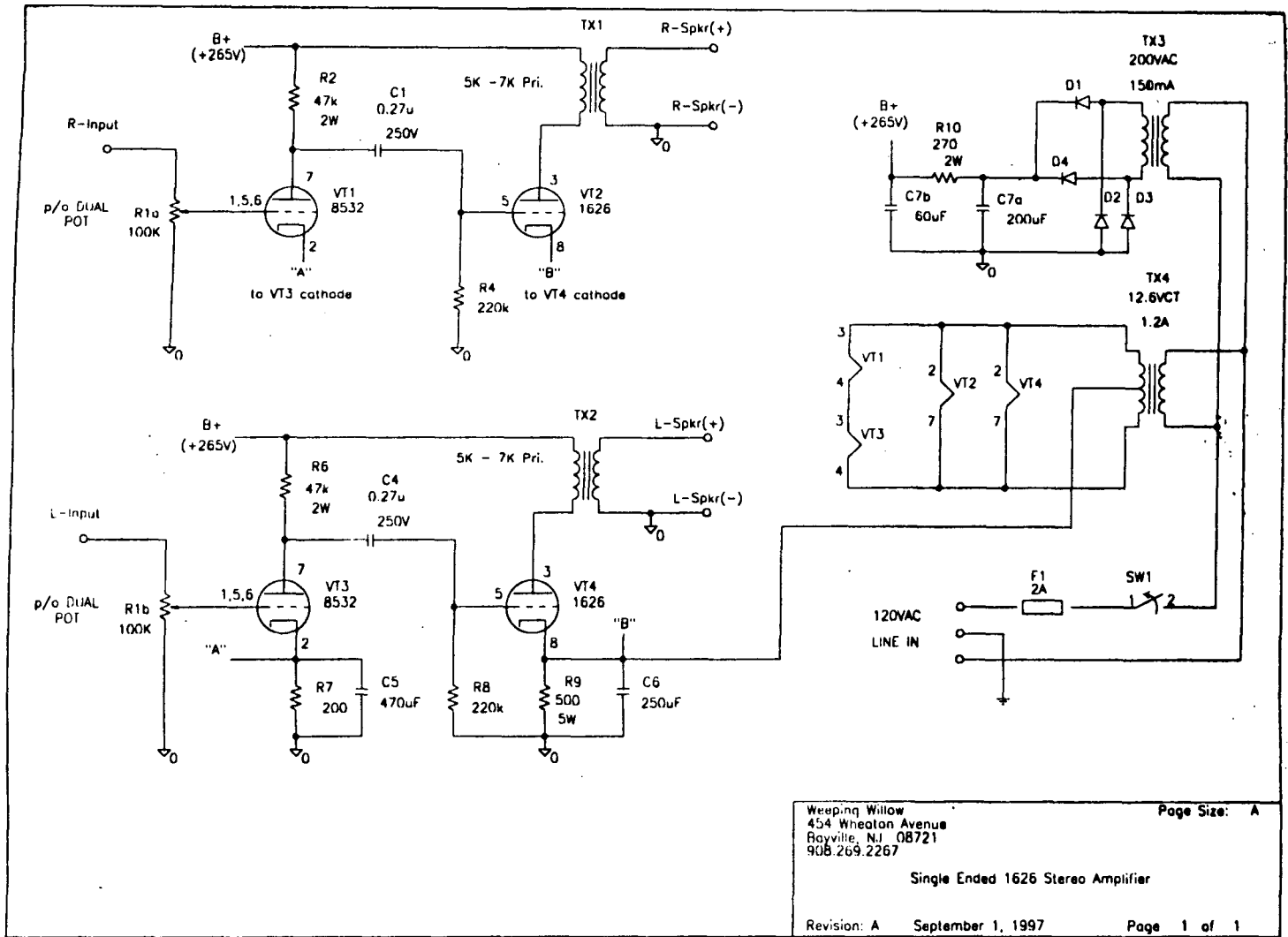

The driver that I eventually fell in love with is shown in Figure 1. It is a simple plate loaded gain stage using the 7-pin miniature high frequency triode, 8532, a ruggedized version of the commercial type 6J4. It has a  $\mu$  of about 52 and a gm of about 11,000  $\mu$ S. It biases up nicely for this application at its maximum plate voltage of 150V, drawing about 3-4mA with a bias of about -2V. This stage gives me a gain of about 32, resulting in an input sensitivity of less than 1V peak, with over 1V of signal headroom.

Higher plate current can be used, but this cuts into input headroom and output swing. Another novelty of the 8532 was its size. It seemed to fit nicely with the "miniature" theme. As you'll see in Photo 1, the finished amp looks like a 1/2 Scale version of a stereo 2A3 or 300B amp. Darling, isn't it?

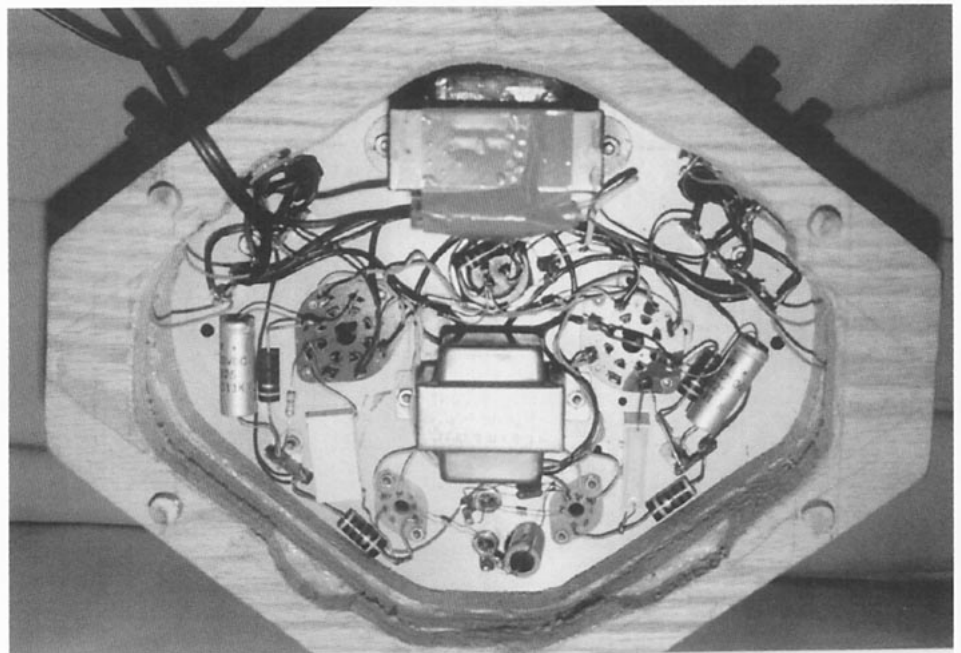



1626

# TRANSMITTING TRIODE

For oscillator applications requiring unusually stable characteristics

|                                     |   |                  |
|-------------------------------------|---|------------------|
| Heater <sup>o</sup>                 | Coated Unipotential Cathode                   |                  |
| Voltage                             | 12.6  | a-c or d-c volts |
| Current                             | 0.25  | amp.             |
| Amplification Factor                | 5   |                  |
| Direct Interelectrode Capacitances: |   |                  |
| Grid to Plate                       | 4.4   | μuf              |
| Grid to Cathode                     | 3.2   | μuf              |
| Plate to Cathode                    | 3.4   | μuf              |
| Maximum Overall Length              |   | 4-1/8"           |
| Maximum Seated Height               |   | 3-9/16"          |
| Maximum Diameter                    |   | 1-9/16"          |
| Bulb                                |   | ST-12            |
| Base                                | Small Shell Octal 8-Pin, HICAROL <sup>h</sup> |                  |

## MAXIMUM CCS RATINGS and TYPICAL OPERATING CONDITIONS

CCS = Continuous Commercial Service

### R-F POWER AMPLIFIER & OSCILLATOR - Class C Telegraphy

Key-down conditions per tube without modulation 0%

|                                |           |               |
|--------------------------------|-----------|---------------|
| D-C Plate Voltage              | 250 max.  | volts         |
| D-C Grid Voltage               | -150 max. | volts         |
| D-C Plate Current              | 25 max.   | ma.           |
| D-C Grid Current               | 8 max.    | ma.           |
| Plate Input                    | 6.25 max. | watts         |
| Plate Dissipation              | 5 max.    | watts         |
| Typical Operation:             |           |               |
| D-C Plate Voltage              | 250       | volts         |
| D-C Grid Voltage <sup>a</sup>  | { -70     | volts         |
|                                | { 14000   | ohms          |
|                                | { 2300    | ohms          |
| Peak R-F Grid Voltage          | 105       | volts         |
| D-C Plate Current              | 25        | ma.           |
| D-C Grid Current <sup>aa</sup> | 5         | approx. ma.   |
| Driving Power <sup>aa</sup>    | 0.5       | approx. watts |
| Power Output                   | 4         | approx. watts |

<sup>o</sup> In circuits where the cathode is not directly connected to the heater, the potential difference between heater and cathode should be kept as low as possible.

<sup>aa</sup> Modulation essentially negative may be used if the positive peak of the audio-frequency envelope does not exceed 115% of the carrier conditions. <sup>a</sup> Obtained from fixed supply (-70), by grid resistor (14000), or cathode resistor (230), or by combination methods. When the 1626 is used in the final amplifier or a preceding stage of a transmitter designed for break-in operation and oscillator keying, a small amount of fixed bias must be used to maintain the plate current at a low value. With plate volts of 250, a fixed bias of at least -35 volts must be used. <sup>h</sup> Subject to wide variations as explained on sheet: TRANS. TUBE RATINGS.

<sup>h</sup> Registered trademark.

Data on operating frequencies for the 1626 are given on the sheet TRANS. TUBE RATINGS vs. FREQUENCY.

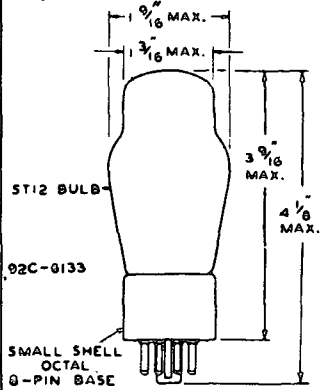

### BOTTOM VIEW OF SOCKET CONNECTIONS

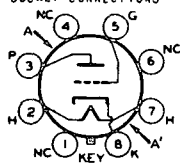

### AA' = PLANE OF ELECTRODES

- Pin 1 - No Connection
- Pin 2 - Heater
- Pin 3 - Plate
- Pin 4 - No Connection
- Pin 5 - Grid
- Pin 6 - No Connection
- Pin 7 - Heater
- Pin 8 - Cathode

TUBE MOUNTING POSITION  
VERTICAL OR HORIZONTAL

MARCH 15, 1941

RCA RADIODRON DIVISION  
RCA MANUFACTURING COMPANY, INC.

TENTATIVE DATA

## Cutting Corners

I guess you could call this amp a study in minimalism: a single 1626 driven by a single 8532 per channel all fed from a common B+ supply. Then, pushing the envelope even further, I called upon a trick sometimes used by commercial stereo manufacturers to reduce parts count and unit cost.

Rather than using separate cathode resistors and bypass caps for each channel, some designs shared the cathode resistor and bypass cap between Left and Right channels. Although I've only seen this done in the output stage, I extended this technique to include the input stage cathodes as well.

Fundamentally, this should work just fine. After all, the bypass cap is essentially an ac short. One short - Two shorts, what's the difference?! Half the cathode resistance, double the capacitance and you're done...Of course, the bypass cap is not a perfect short. At low frequencies its impedance naturally begins to rise. And then there are the effects of ESR and ESL (which will cause an impedance rise at higher frequencies). At worst, this could cause some degree of mixing of left and right signals in each channel. So for a normal stereo input you might expect some crazy phase cancellation effects.

At best, this small degree of "mixing" might be similar to some of those fancy "matrix" enhanced stereo effects found in "room simulators" or early synthetic stereo surround sound systems. In fact, it might actually explain the extraordinarily wide image that this little amp presents. However, for the range of frequencies that we are normally interested in, these effects should be negligible. I have tried both shared and separate cathode circuit elements in this amp. Couldn't really tell a difference....Perhaps another benefit of this approach is that you can now afford to use one good quality bypass cap (Cerafine, Black Gates, etc.) instead of two mediocre ones.

## Construction: Cutting More Corners

As you can see in the photos, shape I chose is rather unusual. The aluminum top plate began its life as an 8" x 10" rectangle. Then the corners were lopped off creating a sort of eight-sided diamond shape. Tubes, Output Transformers, and a can-style dual filter cap are mounted on deck while the small power transformer and separate 12.6 VCT filament transformer are mounted below.

The base was made by laminating three 8" x 10" x 3/4" oak boards and cutting out the middle. Oak was chosen for this approach because it is the only wood that has a decent looking end-grain. Previous attempts at a mitered vertical maple base proved very frustrating. The solid oak approach makes for a much sturdier base, and it fit in better with my home decor, anyway!

The view of the undercarriage shows how much room I had to work with. The worst thing about this layout is the proximity of the filament tranny to the input tubes. I do get a slight bit of hum, as a result. With my speakers (90dB/w/m, Design Acoustic PS-10's) hum is barely audible. Through a friend's (Dave Slagle) "Big-Fun" Lowthers, the hum was more noticeable, but it was soon forgotten about once the music started.

In later versions of the "Darling", I used an 8" x 12" footprint. Moving the filament tranny to the opposite end of the chassis practically eliminated the hum. Another trick that helps reduce heater-induced hum is connecting the filament winding center-tap to a positive potential. This is most conveniently provided by the output stage cathode.

## Wrap-up

To quote a friend, "this amp has no right to

sound as good as it does." The design is nothing special. No rocket science (my day job) employed. No fancy parts were used in the original. But perhaps it is the simplicity of the design that makes it sound the way it does. I'm guessing that I may have lucked into a "synergy" between the 8532 and 1626.

Individually, their characteristics are seemingly "less than optimal" (both create a lot of 2nd harmonic distortion). But together, at the chosen operating points, they seem to complement each other very well. I still haven't figured out why this amp should sound so good, but when I do, I'm going to bottle it!



## AUDI ALTERAM PARTEM

Quality handwound S.E. output transformers

Primaries from 1.8k to 10k

Exclusive wideband design

Silver windings available

Push-pull output transformers

2.5k, 5k, and 10k plate to plate

40 to 75 watt

single 8Ω output

10hz to 40khz

Interstage transformers S.E. and P-P

40 mA primaries

Full bandwidth 20 to 20khz

Custom power transformers/Chokes

Wound to your requirements

DC filament supply windings

HV and high-current chokes

Svetlana and VV output tubes

### ELECTRA-PRINT AUDIO CO.

4117 ROXANNE DRIVE

LAS VEGAS, NV 89108

702-396-4909 / FAX 702-396-4910

e-mail [electaudio@aol.com](mailto:electaudio@aol.com)

Not too many times does lightning hit an industry like single-ended triodes has. But there are still some reviewers and consumers who feel that SE just does not have the power for most speakers. Well here is some information for the right side of your brain that your left side has been saying all the time.

**listen to your left side of your brain**

We listen typically at 84dB's in our listening chair at say 6.5 feet (2M) centered on our speakers. The SPL at 1M away to make 84dB at the chair is only 89dB. So if we have a 89dB efficient speaker at one watt we would have a comfortable output. This leaves us with a ton of options considering most of the SE amps are 8W or better to deliver ample transient information.

If you would like to see the vast amplifier styles and offerings that we have stop by our WEBSITE for the latest information on the Napoleon, Cardinal, Duetto, KIR, Cornet and Junior. Pictured to the right is our new KIR 32W SE mono block amplifiers based on the VV52B with power to spare!

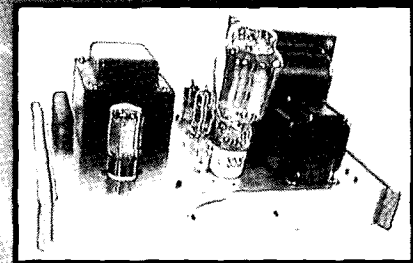
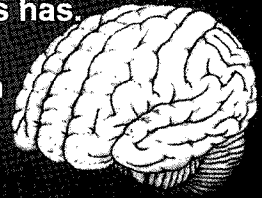

WAVELENGTH



Stop by the WEBSITE to see our line level preamps, phono preamps and speakers

4539 Plainville Road Cincinnati, Ohio 45227 (513) 271-4186

eMail: [waudio@cinti.net](mailto:waudio@cinti.net) WEBSITE: [www.wavelengthaudio.com](http://www.wavelengthaudio.com)